

Cottali



# Cottali



*OLTRE* **45** *ANNI*  
*DI ESPERIENZA*

# Cottali

**Cottali Srl** è da oltre 40 anni sul mercato ed è oggi una delle maggiori produttrici italiane di maniglie ed accessori per porte e finestre; la promozione di maniglie esclusive, rigorosamente "MADE IN ITALY", fa sì che il marchio Cottali sia richiesto e ben conosciuto in oltre 50 stati in tutto il mondo. Il continuo innovamento tecnologico ha straordinariamente permesso all'azienda una costante permanenza e crescita soprattutto nel mercato locale. L'ampia scelta di modelli con diverse fasce di prezzo, oltre ad una ricca gamma di minuteria ed accessoristica con un ottimo rapporto qualità-prezzo, ha fatto sì che la Cottali sia in questo momento annoverata tra i fornitori più validi e riconosciuti anche nel mercato della grande distribuzione.

I nostri punti forza:

#### **Spedizioni anche in 24h**

Grazie all'ampio magazzino di maniglie finite e pronte per la consegna, la Cottali è in grado, all'occorrenza, di evadere un ordine anche in 24h dalla sua conferma.

#### **Maniglie personalizzate**

Cottali è in grado di fornire le impugnature delle maniglie con logo personalizzato.

Vengono altresì realizzate maniglie con inserti di cristallo su disegno del cliente.

#### **Continua ricerca per materiali e sistemi innovativi**

La qualità delle nostre maniglie si esprime anche attraverso i materiali ed i processi di finitura per i quali l'azienda è in continua evoluzione.

Realizziamo maniglie con cesellature, incisioni e rivestimenti in oro e argento.

#### **Assistenza post vendita**

I nostri operatori di vendita sono a disposizione per ogni eventualità ed esigenza, dalla scelta del modello all'istruzione sul montaggio nostre maniglie.

In fine, da non tralasciare, l'eccellente rapporto con la clientela che è alla base del successo di questa azienda.

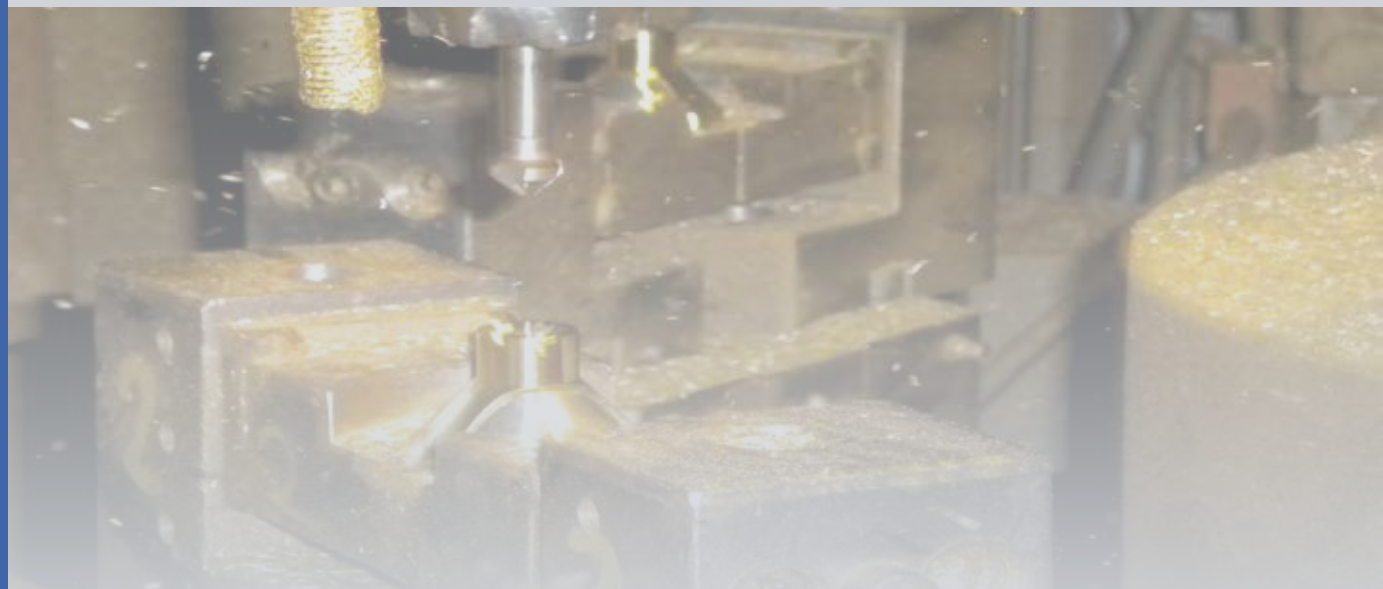



**Cottali Srl** has over 40 years experience on the market and is now one of the leading manufacturers of handles and accessories for door and windows. The promotion of exclusive handles, strictly "MADE IN ITALY", makes the Cottali mark applied for and well known in over 50 countries worldwide. The continuous renovation has allowed the company steady growth, especially in the local market. The wide selection of models with different price ranges, as well as a wide range of accessories, has allowed Cottali to be counted among the most valid and recognized suppliers in the retail market.

Our strengths:

**24 hours delivery time**

Thanks to the large stock of finished products, Cottali is able to deliver orders even in 24 hours from confirmation.

**Customized product**

Cottali can also provide the handles with customer logo and bespoke models.

**Innovation**

The quality of our handles is also expressed through the materials and finishing process for which Cottali is in constantly evolving. We can manufacture handles with carvings, prints, coatings in silver or gold.

**Sales assistance**

Our sales force is at your disposal for any question or need, from the choice of the handle up to the fitting instructions.























Finally, the excellent relationship with our customers is the base of the success of the company.



# INDICE MANIGLIE

<b>LINEA ZAMA</b>	16
<b>LINEA ALLUMINIO</b>	42
<b>LINEA ACCIAIO INOX</b>	52
<b>LINEA OTTONE</b>	58
<b>LINEA FERRO</b>	96
<b>LINEA PLASTICA</b>	100
<b>LINEA PORCELLANA</b>	104

<i>Maniglie</i>	<i>Articolo</i>	<i>Pagina</i>
 <b>A</b>		
<b>ACAPULCO</b>	MA 2.0974	49
	MA 2.9668	48
	MA 2.1160	83
	1.4361	77
	1.2261	79
	1.1361	71
	MA 3.2651	44
	1.9461	65
	MA 2.4561	86
	MA 2.4561 BIC	87

<i>Maniglie</i>	<i>Articolo</i>	<i>Pagina</i>
	ANNA 1.6261	109
	APPLE MA 2.0669	61
	ARCADIA MA 2.5570	63
	ARCO MA 2.0368	56
	ARGO MA 3.2874	20
	ARIA MA 3.0974	25
	ASA MA 2.7361	64
	ATTIK MA 2.8578	62
	AXEL MA 2.8774	56
<b>B</b>		
	BAROCCO 1.5962	65
	BASKET 1.8564	98
	BEA MA 2.8461	36
	BEA BIC MA 2.8461 BIC	36
	BERGAMO MA 2.0168	47
	BERNINI MA 2.8378	62
	BLACK LINE 1.8064	98
	BREMA MA 2.5969	64
<b>C</b>		
	CAMILLE 1.8660	81
	CAPRIX 1.8368	55
	CLARA 1.3861	76
	CLASSIC 1.2561	40
	COMETA MA 2.2461	73
	CORINNE 1.3761	69

# INDICE MANIGLIE

<i>Maniglie</i>	<i>Articolo</i>	<i>Pagina</i>
 <b>CORUS</b>	MA 2.3668	57
 <b>COUPÉ</b>	MA 3.3374	22
<b>D</b>		
 <b>DEA</b>	MA 2.3560	85
 <b>DIAMOND</b>	MA 2.8174	93
 <b>DRÒ</b>	1.8761	78
<b>E</b>		
 <b>ELEGANT</b>	1.6761	71
 <b>ELEMENT</b>	MA 2.9068	34
 <b>ELLE</b>	MA 2.8076	23
 <b>ELLE A</b>	MA 2.8076 A	45
 <b>ELLE BIC</b>	MA 2.8076 BIC	23
 <b>ELLY</b>	MA 2.2760	92
 <b>ERIKA</b>	1.4261	80
 <b>ERIKA BIC</b>	1.4261 BIC	80
 <b>EVA</b>	1.6361	41
<b>F</b>		
 <b>FENIX</b>	MA 3.0774	26
 <b>FIVE</b>	MA 2.0858	34
 <b>FLAT</b>	MA 3.3174	18
 <b>FLEXA</b>	1.0861	74
 <b>FLÒ</b>	1.7960	83
 <b>FLORA</b>	1.2890	65
<b>G</b>		
 <b>GARDA</b>	1.4161	41
 <b>GAUDEL</b>	1.2168	40
 <b>GEA</b>	1.9661	41

<i>Maniglie</i>	<i>Articolo</i>	<i>Pagina</i>
 <b>GEMMA</b>	1.6061	109
 <b>GENOVA</b>	MA 2.8674	93
 <b>GIOVE</b>	1.5460	77
 <b>GOA</b>	MA 3.2358	35
 <b>GOCCIA</b>	MA 2.2161	40
 <b>GOTICA</b>	MA 2.6669	63
 <b>GREEN</b>	1.7270	66
<b>H</b>		
 <b>HAMMER</b>	MA 3.1076	30
 <b>HEAVY</b>	MA 3.0874	25
<b>I</b>		
 <b>IBER</b>	MA 2.3174	95
 <b>IRINA</b>	MA 3.1582	60
 <b>ITACA</b>	MA 3.2974	21
<b>J</b>		
 <b>JAPAN</b>	MA 2.8868	47
<b>K</b>		
 <b>KALU</b>	MA 3.2761	44
 <b>KAROL</b>	1.9561	39
 <b>KIM</b>	MA 2.7661	91
 <b>KIM BIC</b>	MA 2.7661 BIC	91
 <b>KIWI</b>	MA 2.9161	38
 <b>KORA</b>	1.8864	98
 <b>KUBIK</b>	MA 2.6974	94
<b>L</b>		
 <b>LADY</b>	MA 2.1661	86
 <b>LADY BIC</b>	MA 2.1661 BIC	87
 <b>LAMBO PLUS</b>	MA 2.7974 PLUS	24

# INDICE MANIGLIE

<i>Maniglie</i>	<i>Articolo</i>	<i>Pagina</i>
	LARA / GAYA	1.6165 107
	LAURA	MA 2.4174 94
	LIA	MA 2.2861 81
	LIGHT	MA 3.1174 24
	LIMA	MA 3.0474 28
	LINEA	MA 2.2351 90
	LIZ	MA 2.4876 31
	LIZ BIC	MA 2.4876 BIC 31
	LOTUS	MA 2.2574 94
	LUCCA	1.4762 70
	<b>M</b> MALAGA	1.3361 70
	MANU	MA 2.9868 90
	MARE	1.0460 102
	MARIBOR	MA 2.7770 62
	MARINA	MA 2.1261 35
	MARTINA	MA 2.4260 84
	MAXI	MA 2.7861 90
	MEDEA	1.9761 82
	MILANO	1.5768 48
	MINERVA	1.9861 72
	MIRIAM	1.8461 72
	MIRÒ	MA 2.9360 84
	MIRRA	MA 3.3074 19

<i>Maniglie</i>	<i>Articolo</i>	<i>Pagina</i>
	MITO A	MA 2.9968 A 47
	MITO	MA 2.9968 Z 34
	MODÌ	MA 2.5070 89
	MOON	1.0470 102
	<b>N</b> NATALIA	MA 2.5174 95
	NINA	MA 2.6361 74
	NOVANTA	MA 2.1468 55
	NURI	MA 2.6470 89
	<b>O</b> OLARIA	1.1261 75
	OLARIX	1.4868 54
	OLARIX XL 200	MA 2.4068 54
	OLIMPIA	MA 2.1772 85
	OMEGA	MA 2.1968 46
	ONDA	1.0961 73
	OSLO	MA 2.8961 38
	OTTOCENTO	1.3668 49
	OXA	MA 2.2061 85
	<b>P</b> PALMA	MA 2.7161 32
	PARO	1.6861 78
	PAULA	MA 2.6074 93
	PILAR	MA 2.2960 88
	PENDENTE	1.6662 64
	PETRA	MA 3.0068 33



# INDICE MANIGLIE

<i>Maniglie</i>	<i>Articolo</i>	<i>Pagina</i>
	<b>PETRA BIC</b> MA 3.0068 BIC	<b>33</b>
	<b>POLARIS</b> MA 2.6161	<b>86</b>
	<b>POLARIS BIC</b> MA 2.6161 BIC	<b>87</b>
	<b>POLO</b> 1.4060	<b>66</b>
	<b>POROS</b> MA 2.4761	<b>75</b>
	<b>PRAGA</b> 1.2661	<b>91</b>
	<b>PRISMA</b> MA 2.0574	<b>29</b>
	<b>PUNTO</b> MA 2.3760	<b>88</b>
	<b>R</b> <b>RAYA</b> 1.7761	<b>108</b>
	<b>REEF</b> MA 2.5658	<b>32</b>
	<b>RICCIO</b> 1.3569	<b>68</b>
	<b>RIO</b> MA 2.8261	<b>79</b>
	<b>RIVA</b> MA 2.7461	<b>67</b>
	<b>S</b> <b>SABINA</b> MA 2.6860	<b>92</b>
	<b>SAMBA</b> MA 2.4970	<b>88</b>
	<b>SAMIRA</b> MA 2.3974	<b>27</b>
	<b>SATURNIA</b> MA 3.0676	<b>27</b>
	<b>SEDNA</b> 1.9961	<b>76</b>
	<b>SIERRA</b> MA 2.3060	<b>89</b>
	<b>SILVER</b> MA 2.9760	<b>66</b>
	<b>SILVIA</b> 1.2061	<b>71</b>
	<b>SIRIO</b> 1.6960	<b>83</b>
	<b>SLIM</b> MA 3.1276	<b>30</b>

<i>Maniglie</i>	<i>Articolo</i>	<i>Pagina</i>
	<b>SONIA / MAYA</b> 1.4565	<b>106</b>
	<b>SONIA BLU</b> 1.5561	<b>108</b>
	<b>SWING</b> MA 3.2276	<b>29</b>
	<b>T</b> <b>TANGA</b> MA 2.3860	<b>92</b>
	<b>TEKNA</b> MA 2.6774	<b>28</b>
	<b>THEA</b> 1.6468	<b>46</b>
	<b>TORRE</b> MA 2.7261	<b>37</b>
	<b>TORRE BIC</b> MA 2.7261 BIC	<b>37</b>
	<b>TOSCANA</b> 1.2762	<b>70</b>
	<b>TUBOLARE</b> MA 2.5268	<b>48</b>
	<b>U</b> <b>UOVO</b> 1.5261	<b>67</b>
	<b>USA</b> MA 3.2568	<b>49</b>
	<b>V</b> <b>VEGA</b> 1.1161	<b>39</b>
	<b>VEGA PESANTE</b> 1.1161 PES	<b>39</b>
	<b>VERERE</b> 1.7161	<b>69</b>
	<b>VENEZIA</b> 1.2961	<b>68</b>
	<b>VENUS/SEDNA</b> 1.9968 A	<b>46</b>
	<b>VIENNA</b> MA 2.3369	<b>63</b>
	<b>VIERRE</b> 1.0561	<b>82</b>
	<b>VIOLA</b> MA 3.1458	<b>67</b>
	<b>VIRGO</b> MA 2.9474	<b>26</b>
	<b>VOGUE</b> 1.1461	<b>82</b>
	<b>Z</b> <b>ZOE</b> MA 2.6274	<b>95</b>

Serie	Pagina
<b>LINEA ACCESSORI MOBILI</b>	<b>206</b>
<b>SERIE ANTICATO/RESTAURO</b>	<b>225</b>
<b>SERIE MANIGLIETTE</b>	<b>219</b>
<i>Linea Ferro</i>	221
<i>Linea Inox</i>	224
<i>Linea Ottone</i>	219
<i>Linea Porcellana Extra</i>	223
<i>Linea Porcellana Stile</i>	222
<i>Linea Zama</i>	224
<b>SERIE PENDENTI PORCELANA</b>	<b>218</b>
<b>SERIE POMOLINI</b>	<b>207</b>
<i>Linea Ottone</i>	213
<i>Linea Porcellana</i>	207
<i>Linea Zama</i>	216
<b>LINEA ACCESSORI PORTE</b>	<b>147</b>
<b>SERIE BATTENTI PORTA</b>	<b>183</b>
<b>SERIE MANETTONCINI</b>	<b>180</b>
<b>SERIE MANIGLIONI</b>	<b>149</b>
<b>SERIE MANIGLIONI INOX</b>	<b>170</b>
<b>SERIE MANIGLIONI PER ALZANTE</b>	<b>175</b>
<i>Linea Alluminio</i>	177
<i>Linea Ottone</i>	175
<i>Linea Zama</i>	176
<b>SERIE MANIGLIONI PER SERRANDE</b>	<b>148</b>
<b>SERIE MANIGLIONI PORCELLANA</b>	<b>178</b>
<b>SERIE POMOLI ACCOPPIATI</b>	<b>199</b>
<i>Linea Alluminio</i>	202
<i>Linea Porcellana</i>	203
<b>SERIE POMOLI FISSI</b>	<b>190</b>
<i>Linea Alluminio</i>	198
<i>Linea Ferro</i>	197
<i>Linea Inox</i>	197
<i>Linea Ottone</i>	190
<i>Linea Plastica</i>	198
<i>Linea Zama</i>	196
<b>LINEA MINUTERIE OTTONE</b>	<b>232</b>
<b>SERIE ACCESSORI VARI</b>	<b>272</b>
<i>Cavallotti</i>	275
<i>Chiodi</i>	273
<i>Copridadi</i>	273
<i>Cricchetti</i>	274
<i>Distanziali</i>	272
<i>Maniglie blocco</i>	273
<i>Paracolpi</i>	272
<i>Pinze</i>	272
<i>Pozzuoli con molla</i>	274
<i>Pozzuoli senza molla</i>	274
<i>Tavellini</i>	275
<b>SERIE BASI PER NUMERI</b>	<b>240</b>
<b>SERIE BLOCCAPERSIANE</b>	<b>255</b>
<b>SERIE BUCALETTERE</b>	<b>237</b>

Serie	Pagina
<b>SERIE CATENACCI</b>	<b>248</b>
<b>SERIE CATENELLE DI SICUREZZA</b>	<b>243</b>
<b>SERIE CERNIERE</b>	<b>256</b>
<b>SERIE CHIAVI</b>	<b>244</b>
<b>SERIE CHIAVISTELLI</b>	<b>253</b>
<b>SERIE CITOFONI E CAMPANELLI</b>	<b>233</b>
<b>SERIE COPRIAVVOLGIBILI</b>	<b>245</b>
<b>SERIE COPRINTERRUTTORI</b>	<b>247</b>
<b>SERIE LUCCHETTI E CHIUDIORTA</b>	<b>253</b>
<b>SERIE NUMERI E LETTERE</b>	<b>241</b>
<b>SERIE PARACOLPI E FERMAPORTA</b>	<b>254</b>
<b>SERIE PLACCHE PORTANOME</b>	<b>238</b>
<b>SERIE PORTABITI E GANCI</b>	<b>259</b>
<b>SERIE REGGIMENSOLE</b>	<b>269</b>
<b>SERIE SCORRICINGHIA</b>	<b>244</b>
<b>SERIE SET PER TENDE</b>	<b>265</b>
<i>Anelli per tende</i>	265
<i>Mensole per tende</i>	265
<b>SERIE SUPPORTI PER CORRIMANO</b>	<b>266</b>
<b>SERIE TARGHETTE</b>	<b>239</b>
<b>LINEA SCORREVOLI</b>	<b>129</b>
<b>SERIE ACCESSORI</b>	<b>146</b>
<b>SERIE COPPIA MANIGLIA AD INCASSO</b>	<b>140</b>
<b>SERIE KIT NICCHIE</b>	<b>130</b>
<i>Kit senza serratura</i>	136
<b>SERIE MANIGLIA AD INCASSO</b>	<b>142</b>
<b>LINEA SICUREZZA</b>	<b>111</b>
<b>SERIE ACCESSORI PORTE BLINDATE</b>	<b>118</b>
<i>Limitatore a scivolo</i>	125
<i>Limitatori</i>	124
<i>Mostrine</i>	119
<i>Placche</i>	126
<i>Pomoli cilindro</i>	118
<i>Spioncini</i>	119
<b>SERIE DEFENDER</b>	<b>127</b>
<b>SERIE HOTEL</b>	<b>112</b>
<b>SERIE KIT BLINDO</b>	<b>114</b>
<b>SERIE TAGLIAFUOCO</b>	<b>113</b>
<b>LINEA</b>	<b>276</b>
<b>SERIE BOCCHETTE</b>	<b>277</b>
<b>SERIE COPPIA NOTTOLINI WC</b>	<b>281</b>
<b>SERIE FERRAMENTA PER CREMONESI E DK</b>	<b>300</b>
<b>SERIE FERRAMENTA VITI E FERRI</b>	<b>302</b>
<b>SERIE MARTELLINE/CREMONESI</b>	<b>282</b>
<b>SERIE MINI MARTELLINE</b>	<b>292</b>
<b>SERIE PLACCHE MARTELLINE/CREMONESI</b>	<b>295</b>
<b>SERIE PLACCHE MANIGLIE</b>	<b>296</b>
<b>SERIE ROSETTE DK</b>	<b>294</b>
<b>SERIE SEGRETINI</b>	<b>293</b>
<b>SERIE SICURDK</b>	<b>294</b>

Articolo	Variante	Pagina
00716		239
00717		239
00720		239
00730		239
10460		102
10470		102
10561		82
10861		74
10961		73
11092		200
11095		200
11161	PES	39
11161		39
11261		75
11361		71
11461		82
12061		71
12168		40
12261		79
12561		40
12661		91
12762		70
12810		65
12890		65
12961		68
13072		204
13075		204
13082		204
13085		204
13361		70
13569		68
13668		49
13761		69
13861		76
13972		203
13975		203
13982		203
13985		203
14060		66
14161		41
14261	BIC	80
14261		80
14361		77
14510		106
14561		106
14565		106
14660		202
14760		70
14762		70
14863		54
14868		54
15261		67
15460		77
15561		108
15572		204
15575		204
15582		204
15585		204
15768		48
15910		65
15962		65
16061		109
16072		205
16075		205
16082		205
16085		205
16110		107
16161		107
16165		107
16172		203
16175		203
16182		203
16185		203
16261		109

Articolo	Variante	Pagina
16272		205
16275		205
16282		205
16285		205
16361		41
16410		46
16468		46
16619		64
16662		64
16761		71
16861		78
16960		83
17160		69
17161		69
17270		66
17761		108
17960		83
18010		98
18064		98
18363		55
18368		55
18461		72
18510		98
18564		98
18660		81
18761		78
18810		98
18864		98
19116		200
19130		51
19130		201
19130		202
19140		51
19140		202
19210		200
19410		65
19461		65
19561		39
19661		41
19761		82
19860		72
19861		72
19910	A	46
19961		76
19968	A	46
20030		246
22400		244
22480		244
29005		280
29006	18	122
29006	32	122
29006		122
29008		123
29010		123
29012		123
29020	18	122
29020	32	122
29020		122
29022		123
29030	18	279
29030	32	279
29030		279
29032	18	278
29032	32	278
29032		278
29035	18	278
29035	32	123/278
29035		278
29040	18	280
29040		280
29070	18	277
29070	32	277
29070		277
29150	18	57

Articolo	Variante	Pagina
29150		57
29155	18	57
29155		57
29165	18	280
29165		280
29170	18	51
29170		51
29180	18	278
29180	32	278
29180		278
29210	18	279
29210	32	279
29210		279
29220	18	279
29220	32	279
29220		279
29225	18	277
29225	32	277
29225		277
29260	18	277
29260	32	277
29260		277
29900		207
30033		191
30096	06	190
30096	07	190
30096	08	190
30109	17	191
30109	07	191
30116	06	191
30116	07	191
30116	08	191
31060	15	197
32000		192
32001		192
32020	17	192
32025	16	192
32030		190
32040		196
32041		196
32045		196
32090		190
32100		103/198
32110		99/197
32120		99/197
32130		194
32140		195
32150		195
32170	17	194
32170	07	194
32180	17	193
32180	07	193
32250	06	193
32250	07	193
32250	08	193
32260		195
32290		194
32330		260
32340		260
32350		262
32355		261
32356		261
32357		261
32380		262
32385		261
32400		259
32410		197
32470		103
32475		103
32496		260
32510		219
32535		219
32536		219
32550		180

Articolo	Variante	Pagina
32590		219
32595		220
32600		223
32601		223
32602		223
32603		223
32606		223
32607		223
32608		223
32610		220
32615		224
32620		221
32625		148
32626		148
32630		221
32635		221
32640		220
32670		182
32690	16	180
32690	20	180
32695		220
32701		142
32702		142
32703		142
32704		142
32710		142
32712		136
32713		136
32720		143
32721		143
32722		143
32724		143
32732		140
32733		140
32734		140
32760	VT	136
32780		141
32783		141
32784		141
32802		144
32803		144
32812		144
32813		144
32850		281
32860		281
32861	LO	281
32861		281
32866		103
32870	LO	57
32870		57
32872		281
32875		281
32876		281
32890	LO	51
32900		145
32901		145
32912		145
32913		145
32960		145
32961		145
32980		143
32985		143
32990		146
32993		146
33000		222
33001		222
33002		222
33003		222
33006		222
33007		222
33008		222
33010		224
33055		224
34000		253

Articolo	Variante	Pagina
35000		157
35020		157
35030		149
35040		168
35050		167
35060		167
35070		168
35080		162
35140		158
35165		178
35175		178
35185		179
35195		179
35230		160
35260		165
35270		169
35290		160
35325		179
35330		161
35340		166
35350		166
35360		159
35370		159
35380		169
35400		156
35412		163
35420		61
35430		182
35450		156
35470		158
35480		151
35490		149
35500		154
35512		163
35530	SL	154
35533		154
35540		155
35612		162
35620		181
35630		181
35640		164
35659		165
35660	SL	161
35660		161
35670		150
35680		155
35700		172
35710	OIS	173
35720	OIS	173
35750	OIS	174
35760	OIS	173
35730	OIS	174
35770		170
35780		170
35790		172
35800		175
35810	BIC	176
35810		176
35830		177
35840		177
35850		177
35870	BIC	176
35870		176
35890		177
35900		175
35910		151
35920		152
35930		150
35959		152
35960		164
35970	BIC	153
35970		153
35980		171
35990		171

Articolo	Variante	Pagina
35995		172
36400		50/198
36450		50/198
36500		50/198
36500		198
37260		260
38000		207
38001		207
38002		207
38003		207
38006		207
38007		208
38008		208
38010		208
38011		208
38013		208
38015		208
38020		209
38023		209
38025		209
38030		209
38031		209
38032		209
38033		210
38040		210
38041		210
38043		210
38044		210
38046		210
38047		211
38048		211
38049		211
38070		211
38071		211
38072		211
38073		212
38074		212
38075		212
38076		212
38078		212
38083		212
38120		212
38190		218
38191		218
38192		218
38193		218
38194		218
38195		218
38196		218
38197		213
38199		218
38540		213
38560		213
38570		216
38590		216
38610		217
38615		231
38625		231
38630		217
38635		231
38640		231
38645		231
38655		217
38665		231
38710	Z	216
38710		213
38715		214
38720		214
38725		214
38730		214
38733		214
38745		215
38750		215
38760		215

Articolo	Variante	Pagina
38765		217
38778		215
38780		215
38790		216
38810		216
38830		217
38880		217
40110		292
40410		102
40460		102
40470		102
40560		82
40860		74
40960		73
41110		288
41120	70	292
41120		293
41160		39
41260		75
41320	70	292
41320		293
41360		71
41460		82
42010		287
42060		71
42160		40
42210		289
42260		79
42314		244
42315		244
42316		244
42510		286
42560		40
42660		91
42712		282
42760		70
42810		284
42911		283
42960		68
43311		283
43360		70
43522		282
43560		68
43660		49
43760		69
43860		76
44060		66
44160		41
44210	BIC	285
44210		285
44260	BIC	80
44260		80
44310		285
44360		77
44510		106
44560		106
44711		282
44860		54
45260		67
45460		77
45510		108
45560		108
45760		48
45910		284
46010		109
46060		109
46110		107
46160		107
46210		109
46260		109
46310		287
46360		41
46410		291
46460		46

Articolo	Variante	Pagina
46619		284
46720	70	292
46720		293
46760		71
46819		286
46860		78
46960		83
47260		66
47760		108
47960		83
48360		55
48410		288
48460		72
48510		291
48660		81
48710		289
48760		78
49410		283
49510		245
49510	Martellina	288
49515		246
49530		245
49540		246
49560		39
49660		41
49760		82
49910		287
49960	A	46
49960		76
54030		249
54050		249
54060		249
54066		249
54075		250
54080		250
54100		250
54175		253
54180		251
54200		252
54230		247
54240		252
54250		251
54270		251
54300		251
54321		127
54323		127
54330		120
54331		120
54332		120
54333		120
54339		120
54340		121
54341		121
54342		121
54343		121
54349		121
54500		257
54501		257
54510		257
54511		257
54520		257
54521		257
54530		257
54531		257
54600		256
54601		257
54610		256
54611		256
54712		256
54715		257
54716		257
54720		258
54721		258
54730		258

Articolo	Variante	Pagina
54731		258
54735		258
54736		258
54740		258
54741		258
54750		258
54751		258
55330		126
55331		126
55332		126
55333		126
55340		272
56330		119
56331		119
56332		119
60001		272
60002		272
60010		255
60012		255
60015	00	252
60021		274
60022		274
60027		274
60040		254
60045		254
60051		273
60060		274
60061		274
60070		266
60071		266
60073		267
60074		267
60075		268
60080		267
60081		267
60085		266
60088		268
60089		268
60090		243
60100		275
60108		275
60110		275
60120		273
60121		273
60135		118
60136		118
60138		118
60139		118
60149		118
60150		124
60151		124
60153		124
60156		124
60157		125
60170		255
60180		255
60190		253
60195		253
60876		125
60877		125
60950		254
60960		254
60990		272
60999		254
61000		254
61014		263
61016		263
61017		263
61018		263
61059		263
61060		263
61062		263
61063		263
61146		264

# INDICE ALFANUMERICO

Articolo	Variante	Pagina
61147		264
61149		263
61151		263
61152		263
61200		264
61390		264
61420		270
61430		270
61435		270
61440		269
61460		270
61461		270
61462		270
61463		270
61464		270
61560		271
61570		265
61571		265
61572		265
61582		271
61583		271
63300		273
63305		273
64200		265
64250		265
65050		253
65410		226
65411		226
65420		227
65810		227
65840		227
65860		228
65861		228
65881		228
65900		228
65901		228
65970		228
65971		228
66000		225
66001		225
66010		228
66060		226
66061		226
66070		227
66080		227
66090		227
66131		228
66133		217
66200		229
66205		229
66240		229
66250		229
66260		229
66270		230
66300		229
66410		230
66420		230
66421		230
66422		230
66430		230
66431		230
66440		230
66470		230
70010		238
70020		238
70021		238
70110		238
70310		272
72010	01	233
72010	02	233
72020		233
72025		235
72050		234
72051		234

Articolo	Variante	Pagina
72053		234
72054		234
72055		235
72056		235
72060		236
72070		236
72080		236
72090		235
72100		236
72130		236
73140		237
73145		237
73160		237
73170		237
74010		185
74013		184
74014		184
74015		185
74027		188
74060		188
74075		186
74080		243
74081		243
74090		243
74110		188
74130		187
74140		187
74150		187
74160		186
74170		186
74180		189
74190		189
74200		189
74210		183
74230		99
74240		99
74250		99
74280		185
75040		146
75050		146
75060		146
75065		146
75100	FZVTN	130
75110	FZN	131
75150		131
75170	FZN	135
75200	01	138
75200		132
75210	01	138
75210		132
75220		138
75300	01 FZVTN	137
75300	FZVTN	134
75310	01 FZ	137
75310	FZN	134
75320	FZ	137
75340	FZN	135
75400	01	139
75400		133
75410	01	139
75410		133
75420		139
82000		247
82030		247
82060		247
82090		247
90045		303
90060		301
90062		301
90065		301
90067		294
90069	04	301
90069	08	301
90070		300

Articolo	Variante	Pagina
90075		300
90080		300
90085		300
90090		300
90095		300
90120		300
90125		300
90135		302
90140		302
90200		303
90201		303
90202		303
90203		303
90204		303
90205		303
90206		301
90300		170/171
90310		170/171
90531	02	119
90531	03	119
90531	06	119
90781		302
90782		302
90785		302
90786		302
90910		241
90915		241
90920		241
90930		241
90945		241
90948		242
90950		242
90960		242
90990		242
91050	01	240
91050	02	240
91050	03	240
91050	04	240
91060		240
CHV101801		112
CHV301801		112
CPB16468		117
CPB16470		116
CPB19561		115
CPB21910		116
CPB21968		117
FI11160	PES	39
FI20360		56
FI20570		29
FI20660		61
FI20860		34
FI20860		47
FI20970		49
FI21160		83
FI21260		35
FI21460		55
FI21660	BIC	87
FI21660		86
FI21760		85
FI21910		291
FI21960		46
FI22060		85
FI22110		290
FI22160		40
FI22360		90
FI22460		73
FI22560		49
FI22570		94
FI22760		92
FI22860		81
FI22960		88
FI23060		89
FI23170		95
FI23360		63

Articolo	Variante	Pagina
FI23560		85
FI23660		57
FI23760		88
FI23860		92
FI23970		27
FI24060		88
FI24170		94
FI24260		84
FI24560	BIC	87
FI24560		86
FI24760		75
FI24838		31
FI24838		290
FI24870	BIC	31
FI24870		31
FI25060		89
FI25170		95
FI25260		48
FI25560		63
FI25660		32
FI25960		64
FI26070		93
FI26160	BIC	87
FI26160		86
FI26270		95
FI26360		74
FI26460		89
FI26669		63
FI26770		28
FI26860		92
FI26970		94
FI27160		32
FI27260	BIC	37
FI27260		37
FI27360		64
FI27410		289
FI27460		67
FI27660	BIC	91
FI27660		91
FI27760		62
FI27860		90
FI27970	PLUS	24
FI28038		23
FI28038		290
FI28070	A	45
FI28070	BIC	23
FI28070		23
FI28170		93
FI28210		286
FI28260		79
FI28360		62
FI28460	BIC	36
FI28460		36
FI28560		62
FI28670		93
FI28770		56
FI28860		47
FI28960		38
FI29060		34
FI29160		38
FI29360		84
FI29470		26
FI29660		48
FI29760		66
FI29860		90
FI29960	A	47
FI29960	Z	34
FI30060	BIC	33
FI30060		33
FI30470		28
FI30670		27
FI30770		26
FI30870		25
FI30970		25

Articolo	Variante	Pagina
FI31070		30
FI31170		24
FI31270		30
FI31460		67
FI31560		60
FI32270		29
FI32360		35
FI32660		44
FI32760		44
FI32870		20
FI32970		21
FI33070		19
FI33170		18
FI33370		22
KB19568ES/NY		115
KB21968ES/NY		114
KB28076ES/NY		114
MA20168		47
MA20368		56
MA20574		29
MA20669		61
MA20868		34
MA20974		49
MA21160		83
MA21261		35
MA21463		55
MA21468		55
MA21661	BIC	87
MA21661		86
MA21772		85
MA21910		46
MA21968		46
MA22061		85
MA22161		40
MA22351		90
MA22461		73
MA22568		49
MA22574		94
MA22760		92
MA22861		81
MA22960		88
MA22976		88
MA23060		89
MA23174		95
MA23369		63
MA23560		85
MA23668		57
MA23760		88
MA23860		92
MA23958		27
MA23974		27
MA24068		54
MA24174		94
MA24260		84
MA24561	BIC	87
MA24561		86
MA24761		75
MA24876	BIC	31
MA24876		31
MA24970		88
MA25070		89
MA25174		95
MA25268		48
MA25570		63
MA25658		32
MA25674		32
MA25969		64
MA26074		93
MA26161	BIC	87
MA26161		86
MA26274		95
MA26361		74
MA26470		89
MA26669		63

Articolo	Variante	Pagina
MA26774		28
MA26860		92
MA26974		94
MA27161		32
MA27176		32
MA27261	BIC	37
MA27261		37
MA27361		64
MA27461		67
MA27661	BIC	91
MA27661		91
MA27770		62
MA27861		90
MA27974	PLUS	24
MA28076	A	45
MA28076	BIC	23
MA28076		23
MA28174		93
MA28261		79
MA28378		62
MA28461	BIC	36
MA28461		36
MA28578		62
MA28674		93
MA28774		56
MA28868		47
MA28961		38
MA29068		34
MA29161		38
MA29210		113
MA29360		84
MA29458		26
MA29474		26
MA29668		48
MA29760		66
MA29868		90
MA29968	A	47
MA29968	Z	34
MA30068	BIC	33
MA30068		33
MA30076	BIC	33
MA30076		33
MA30474		28
MA30651		27
MA30676		27
MA30758		26
MA30774		26
MA30858		25
MA30874		25
MA30958		25
MA30974		25
MA31076		30
MA31174		24
MA31276		30
MA31458		67
MA31458		210
MA31582		60
MA32276		29
MA32358		35
MA32651		44
MA32761		44
MA32858		20
MA32874		20
MA32958		21
MA32974		21
MA33058		19
MA33074		19
MA33158		18
MA33174		18
MA33358		22
MA33374		22
PO22576		199
PO32074		199



CC





ottali

LINEA

ZAMA

**Art. MA 3.3174**

Guarnitura rosetta staccata e bocchetta quadra 50x50 mm a pressione.  
Door handle on 50x50 mm pressured unassembled rose and escutcheon.

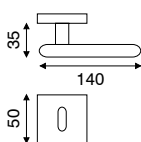

FINITURA FINISH	CRS	NR OP
--------------------	-----	----------

**Art. FI 3.3170**

DK movimento in fibra con rosetta rettangolare 31x61 mm.  
DK nylon mechanism on rectangular rose 31x61 mm.

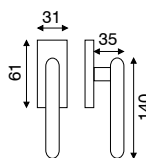

FINITURA FINISH	CRS	NR OP
--------------------	-----	----------

**Art. MA 3.3158**

Guarnitura rosetta staccata e bocchetta tonda ø 50 mm a pressione.  
Door handle on ø 50 mm pressured unassembled rose and escutcheon.

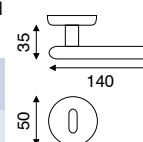

FINITURA FINISH	CRS	NR OP
--------------------	-----	----------

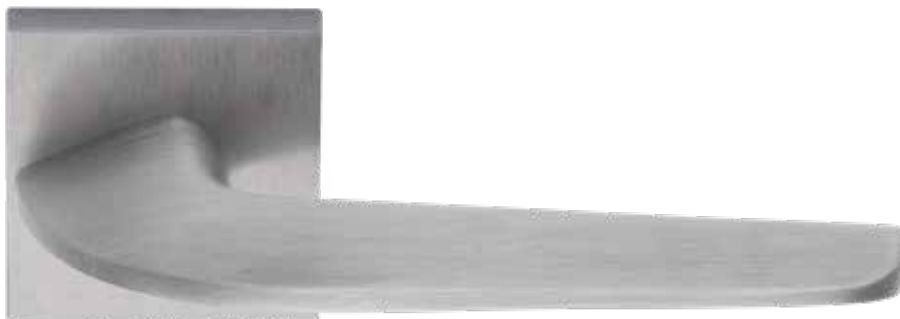
**Art. MA 3.3074**

Guarnitura rosetta staccata e bocchetta quadra 50x50 mm a pressione.  
Door handle on 50x50 mm pressured unassembled rose and escutcheon.

FINITURA FINISH	CRS	NR OP

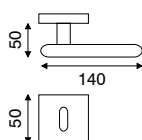
**Art. FI 3.3070**

DK movimento in fibra con rosetta rettangolare 31x61 mm.  
DK nylon mechanism on rectangular rose 31x61 mm.

FINITURA FINISH	CRS	NR OP

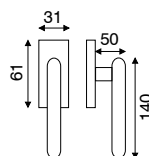
**Art. MA 3.3058**

Guarnitura rosetta staccata e bocchetta tonda ø 50 mm a pressione.  
Door handle on ø 50 mm pressured unassembled rose and escutcheon.

FINITURA FINISH	CRS	NR OP

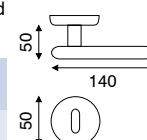

**Art. MA 3.2874**

Guarnitura rosetta staccata e bocchetta quadra 50x50 mm a pressione.  
Door handle on 50x50 mm pressured unassembled rose and escutcheon.

FINITURA FINISH	CRS	NR OP	OGR OP

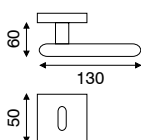
**Art. FI 3.2870**

DK movimento in fibra con rosetta rettangolare 31x61 mm.  
DK nylon mechanism on rectangular rose 31x61 mm.

FINITURA FINISH	CRS	NR OP	OGR OP

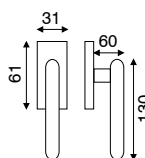
**Art. MA 3.2858**

Guarnitura rosetta staccata e bocchetta tonda ø 50 mm a pressione.  
Door handle on ø 50 mm pressured unassembled rose and escutcheon.

FINITURA FINISH	CRS	NR OP	OGR OP

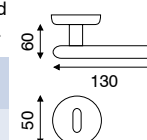



**Art. MA 3.2974**

Guarnitura rosetta staccata e bocchetta quadra 50x50 mm a pressione.  
Door handle on 50x50 mm pressured unassembled rose and escutcheon.

FINITURA	CRS	NR	OGR
FINISH		OP	OP

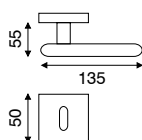

**Art. FI 3.2970**

DK movimento in fibra con rosetta rettangolare 31x61 mm.  
DK nylon mechanism on rectangular rose 31x61 mm.

FINITURA	CRS	NR	OGR
FINISH		OP	OP

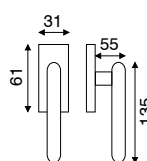

**Art. MA 3.2958**

Guarnitura rosetta staccata e bocchetta tonda ø 50 mm a pressione.  
Door handle on ø 50 mm pressured unassembled rose and escutcheon.

FINITURA	CRS	NR	OGR
FINISH		OP	OP

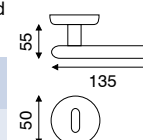

**Art. MA 3.3374**

Guarnitura rosetta staccata e bocchetta quadra 50x50 mm a pressione.  
Door handle on 50x50 mm pressured unassembled rose and escutcheon.

FINITURA  
FINISH CRS

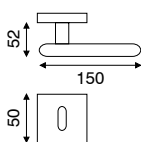
**Art. FI 3.3370**

DK movimento in fibra con rosetta rettangolare 31x61 mm.  
DK nylon mechanism on rectangular rose 31x61 mm.

FINITURA  
FINISH CRS

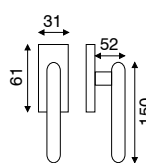
**Art. MA 3.3358**

Guarnitura rosetta staccata e bocchetta tonda ø 50 mm a pressione.  
Door handle on ø 50 mm pressured unassembled rose and escutcheon.

FINITURA  
FINISH CRS

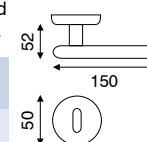



**Art. FI 2.8038**

Vedi pagina 290.

**Art. MA 2.8076**

Guarnitura rosetta staccata e bocchetta quadra 50x50 mm a pressione.  
Door handle on 50x50 mm pressured unassembled rose and escutcheon.

FINITURA FINISH	CRS	CR
--------------------	-----	----

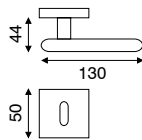

**Art. FI 2.8070**

DK movimento in fibra con rosetta rettangolare 31x61 mm.  
DK nylon mechanism on rectangular rose 31x61 mm.

FINITURA FINISH	CRS	CR
--------------------	-----	----

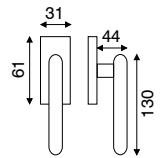

**Art. MA 2.8076 BIC**

Guarnitura rosetta staccata e bocchetta quadra 50x50 mm a pressione.  
Door handle on 50x50 mm pressured unassembled rose and escutcheon.

FINITURA FINISH	CR/CRS
--------------------	--------

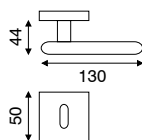

**Art. FI 2.8070 BIC**

DK movimento in fibra con rosetta rettangolare 31x61 mm.  
DK nylon mechanism on rectangular rose 31x61 mm.

FINITURA FINISH	CR/CRS
--------------------	--------

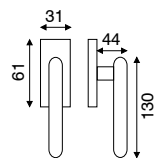

# SERIE LIGHT

CON CRISTALLO



## Art. MA 3.1174

Guarnitura rosetta staccata e bocchetta quadra 50x50 mm a pressione.  
Door handle on 50x50 mm pressured unassembled rose and escutcheon.

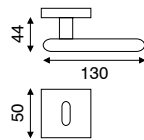

FINITURA  
FINISH

CR/KR

## Art. FI 3.1170

DK movimento in fibra con rosetta rettangolare 31x61 mm.  
DK nylon mechanism on rectangular rose 31x61 mm.

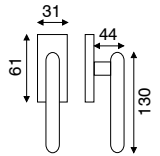

FINITURA  
FINISH

CR/KR

# SERIE LAMBO PLUS



## Art. MA 2.7974 PLUS

Guarnitura rosetta staccata e bocchetta quadra 50x50 mm a pressione.  
Door handle on 50x50 mm pressured unassembled rose and escutcheon.

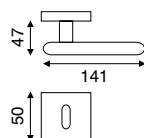

FINITURA  
FINISH

CRS

CR

## Art. FI 2.7970 PLUS

DK movimento in fibra con rosetta rettangolare 31x61 mm.  
DK nylon mechanism on rectangular rose 31x61 mm.

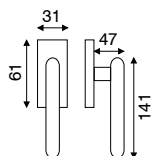

FINITURA  
FINISH

CRS

CR



## SERIE HEAVY



### Art. MA 3.0874

Guarnitura rosetta staccata e bocchetta quadra 50x50 mm a pressione. Door handle on 50x50 mm pressured unassembled rose and escutcheon.

FINITURA FINISH	CRS
--------------------	-----

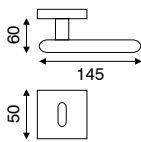

### Art. FI 3.0870

DK movimento in fibra con rosetta rettangolare 31x61 mm. DK nylon mechanism on rectangular rose 31x61 mm.

FINITURA FINISH	CRS
--------------------	-----

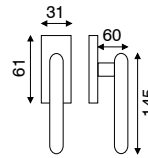

### Art. MA 3.0858

Guarnitura rosetta staccata e bocchetta tonda ø 50 mm a pressione. Door handle on ø 50 mm pressured unassembled rose and escutcheon.

FINITURA FINISH	CRS
--------------------	-----

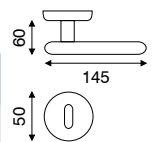

## SERIE ARIA



### Art. MA 3.0974

Guarnitura rosetta staccata e bocchetta quadra 50x50 mm a pressione. Door handle on 50x50 mm pressured unassembled rose and escutcheon.

FINITURA FINISH	CRS
--------------------	-----

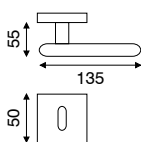

### Art. FI 3.0970

DK movimento in fibra con rosetta rettangolare 31x61 mm. DK nylon mechanism on rectangular rose 31x61 mm.

FINITURA FINISH	CRS
--------------------	-----

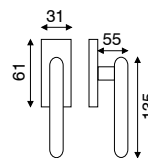

### Art. MA 3.0958

Guarnitura rosetta staccata e bocchetta tonda ø 50 mm a pressione. Door handle on ø 50 mm pressured unassembled rose and escutcheon.

FINITURA FINISH	CRS
--------------------	-----

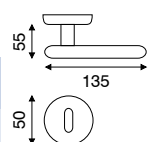

# SERIE FENIX



## Art. MA 3.0774

Guarnitura rosetta staccata e bocchetta quadra 50x50 mm a pressione. Door handle on 50x50 mm pressured unassembled rose and escutcheon.

FINITURA FINISH	CRS
--------------------	-----

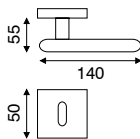

## Art. FI 3.0770

DK movimento in fibra con rosetta rettangolare 31x61 mm. DK nylon mechanism on rectangular rose 31x61 mm.

FINITURA FINISH	CRS
--------------------	-----

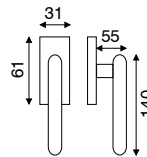

## Art. MA 3.0758

Guarnitura rosetta staccata e bocchetta tonda ø 50 mm a pressione. Door handle on ø 50 mm pressured unassembled rose and escutcheon.

FINITURA FINISH	CRS
--------------------	-----

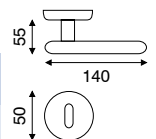

# SERIE VIRGO



## Art. MA 2.9474

Guarnitura rosetta staccata e bocchetta quadra 50x50 mm a pressione. Door handle on 50x50 mm pressured unassembled rose and escutcheon.

FINITURA FINISH	CRS	CR
--------------------	-----	----

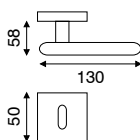

## Art. FI 2.9470

DK movimento in fibra con rosetta rettangolare 31x61 mm. DK nylon mechanism on rectangular rose 31x61 mm.

FINITURA FINISH	CRS	CR
--------------------	-----	----

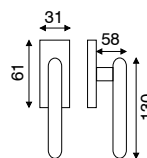

## Art. MA 2.9458

Guarnitura rosetta staccata e bocchetta tonda ø 50 mm a pressione. Door handle on ø 50 mm pressured unassembled rose and escutcheon.

FINITURA FINISH	CRS	CR
--------------------	-----	----

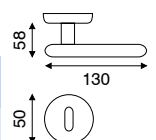

## SERIE SAMIRA

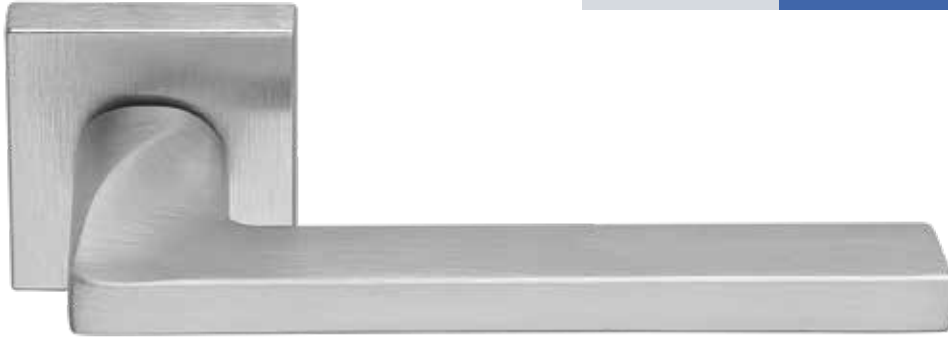

### Art. MA 2.3974

Guarnitura rosetta staccata e bocchetta quadra 50x50 mm a pressione.  
Door handle on 50x50 mm pressured unassembled rose and escutcheon.

FINITURA FINISH	CRS	OGR OP
--------------------	-----	-----------

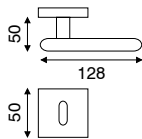

### Art. FI 2.3970

DK movimento in fibra con rosetta rettangolare 31x61 mm.  
DK nylon mechanism on rectangular rose 31x61 mm.

FINITURA FINISH	CRS	OGR OP
--------------------	-----	-----------

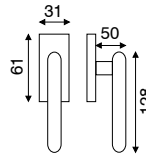

### Art. MA 2.3958

Guarnitura rosetta staccata e bocchetta tonda ø 50 mm a pressione.  
Door handle on ø 50 mm pressured unassembled rose and escutcheon.

FINITURA FINISH	CRS	OGR OP
--------------------	-----	-----------

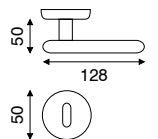

## SERIE SATURNIA



### Art. MA 3.0676

Guarnitura rosetta staccata e bocchetta quadra 45x45 mm a pressione.  
Door handle on 45x45 mm pressured unassembled rose and escutcheon.

FINITURA FINISH	CRS	
--------------------	-----	--

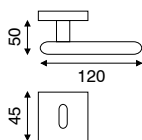

### Art. FI 3.0670

DK movimento in fibra con rosetta rettangolare 31x61 mm.  
DK nylon mechanism on rectangular rose 31x61 mm.

FINITURA FINISH	CRS	
--------------------	-----	--

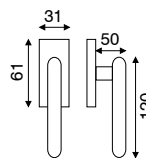

### Art. MA 3.0651

Guarnitura rosetta staccata e bocchetta tonda ø 45 mm a pressione.  
Door handle on ø 45 mm pressured unassembled rose and escutcheon.

FINITURA FINISH	CRS	
--------------------	-----	--

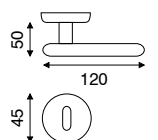

# SERIE TEKNA



## Art. MA 2.6774

Guarnitura rosetta staccata e bocchetta quadra 50x50 mm a pressione.  
Door handle on 50x50 mm pressured unassembled rose and escutcheon.

FINITURA FINISH	CRS
--------------------	-----

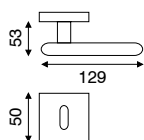

## Art. FI 2.6770

DK movimento in fibra con rosetta rettangolare 31x61 mm.  
DK nylon mechanism on rectangular rose 31x61 mm.

FINITURA FINISH	CRS
--------------------	-----

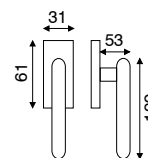

# SERIE LIMA



## Art. MA 3.0474

Guarnitura rosetta staccata e bocchetta quadra 50x50 mm a pressione.  
Door handle on 50x50 mm pressured unassembled rose and escutcheon.

FINITURA FINISH	CRS
--------------------	-----

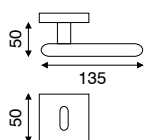

## Art. FI 3.0470

DK movimento in fibra con rosetta rettangolare 31x61 mm.  
DK nylon mechanism on rectangular rose 31x61 mm.

FINITURA FINISH	CRS
--------------------	-----

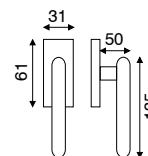

# SERIE PRISMA



## Art. MA 2.0574

Guarnitura rosetta staccata e bocchetta quadra 50x50 mm a pressione.  
Door handle on 50x50 mm pressured unassembled rose and escutcheon.

FINITURA FINISH	CRS
-----------------	-----

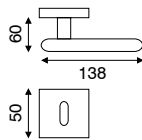

## Art. FI 2.0570

DK movimento in fibra con rosetta rettangolare 31x61 mm.  
DK nylon mechanism on rectangular rose 31x61 mm.

FINITURA FINISH	CRS
-----------------	-----

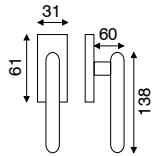

# SERIE SWING



## Art. MA 3.2276

Guarnitura rosetta staccata e bocchetta quadra 45x45 mm a pressione.  
Door handle on 45x45 mm pressured unassembled rose and escutcheon.

FINITURA FINISH	CRS	CR
-----------------	-----	----

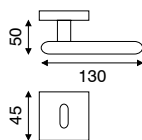

## Art. FI 3.2270

DK movimento in fibra con rosetta rettangolare 31x61 mm.  
DK nylon mechanism on rectangular rose 31x61 mm.

FINITURA FINISH	CRS	CR
-----------------	-----	----

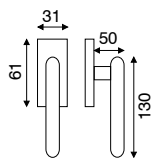

## SERIE HAMMER



### Art. MA 3.1076

Guarnitura rosetta staccata e bocchetta quadra 45X45 mm a pressione.  
Door handle on 45X45 mm pressured unassembled rose and escutcheon.

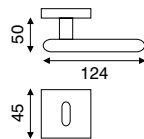

FINITURA  
FINISH CRS

### Art. FI 3.1070

DK movimento in fibra con rosetta rettangolare 31x61 mm.  
DK nylon mechanism on rectangular rose 31x61 mm.

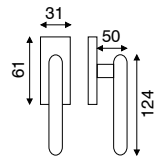

FINITURA  
FINISH CRS

## SERIE SLIM

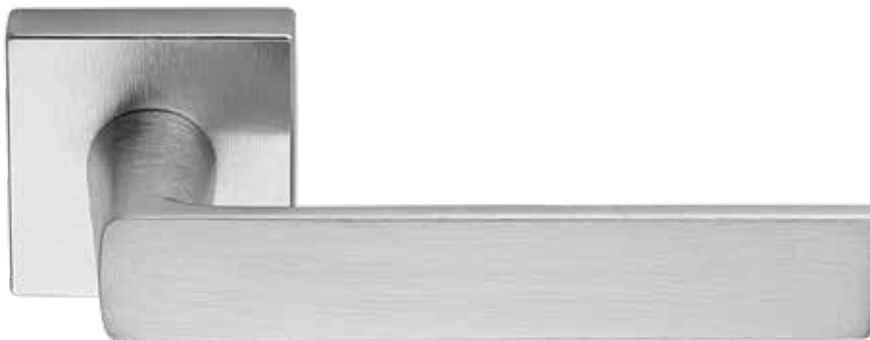

### Art. MA 3.1276

Guarnitura rosetta staccata e bocchetta quadra 45X45 mm a pressione.  
Door handle on 45X45 mm pressured unassembled rose and escutcheon.

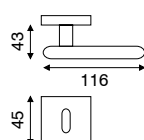

FINITURA  
FINISH CRS

### Art. FI 3.1270

DK movimento in fibra con rosetta rettangolare 31x61 mm.  
DK nylon mechanism on rectangular rose 31x61 mm.

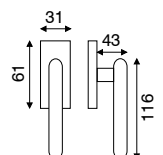

FINITURA  
FINISH CRS

## SERIE LIZ



**Art. FI 2.4838**

Vedi pagina 290.

### Art. MA 2.4876

Guarnitura rosetta staccata e bocchetta quadra 45X45 mm a pressione.

Door handle on 45X45 mm pressured unassembled rose and escutcheon.

FINITURA FINISH	CRS	CR
--------------------	-----	----

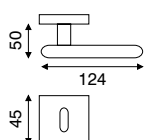

### Art. FI 2.4870

DK movimento in fibra con rosetta rettangolare 31x61 mm.

DK nylon mechanism on rectangular rose 31x61 mm.

FINITURA FINISH	CRS	CR
--------------------	-----	----

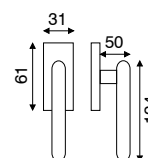

## SERIE LIZ BIC



### Art. MA 2.4876 BIC

Guarnitura rosetta staccata e bocchetta quadra 45X45 mm a pressione.

Door handle on 45X45 mm pressured unassembled rose and escutcheon.

FINITURA FINISH	CR/CRS
--------------------	--------

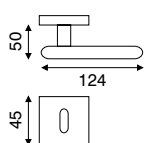

### Art. FI 2.4870 BIC

DK movimento in fibra con rosetta rettangolare 31x61 mm.

DK nylon mechanism on rectangular rose 31x61 mm.

FINITURA FINISH	CR/CRS
--------------------	--------

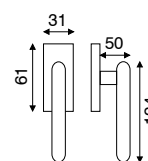

## SERIE REEF



### Art. MA 2.5658

Guarnitura rosetta staccata e bocchetta  $\varnothing$  50 mm a pressione.  
Door handle on  $\varnothing$  50 mm pressured unassembled rose and escutcheon.

FINITURA FINISH	CRS
--------------------	-----

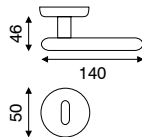

### Art. FI 2.5660

DK movimento in fibra con rosetta ovale 31x61 mm.  
DK nylon mechanism on oval rose 31x61 mm.

FINITURA FINISH	CRS
--------------------	-----

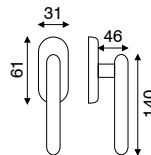

### Art. MA 2.5674

Guarnitura rosetta staccata e bocchetta quadra 50x50 mm a pressione.  
Door handle on 50x50 mm pressured unassembled rose and escutcheon.

FINITURA FINISH	CRS
--------------------	-----

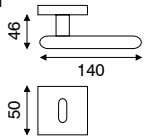

## SERIE PALMA



### Art. MA 2.7161

Guarnitura rosetta e bocchetta  $\varnothing$  45 mm a pressione.  
Door handle on  $\varnothing$  45 mm pressured fixed rose and escutcheon.

FINITURA FINISH	CRS
--------------------	-----

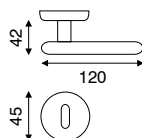

### Art. FI 2.7160

DK movimento in fibra con rosetta ovale 31x61 mm.  
DK nylon mechanism on oval rose 31x61 mm.

FINITURA FINISH	CRS
--------------------	-----

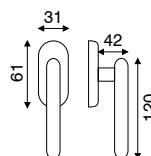

### Art. MA 2.7176

Guarnitura rosetta staccata e bocchetta quadra 45x45 mm a pressione.  
Door handle on 45x45 mm pressured unassembled rose and escutcheon.

FINITURA FINISH	CRS
--------------------	-----

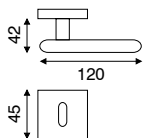



## SERIE PETRA



### Art. MA 3.0068

Guarnitura rosetta e bocchetta  $\varnothing$  50 mm a pressione.  
Door handle on  $\varnothing$  50 mm pressured fixed rose and escutcheon.

FINITURA FINISH	CRS
--------------------	-----

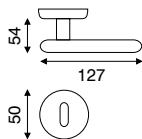

### Art. FI 3.0060

DK movimento in fibra con rosetta ovale 31x61 mm.  
DK nylon mechanism on oval rose 31x61 mm.

FINITURA FINISH	CRS
--------------------	-----

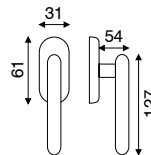

### Art. MA 3.0076

Guarnitura rosetta staccata e bocchetta quadra 45x45 mm a pressione.  
Door handle on 45x45 mm pressured unassembled rose and escutcheon.

FINITURA FINISH	CRS
--------------------	-----

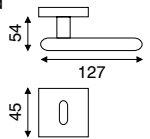

## SERIE PETRA BIC



### Art. MA 3.0068 BIC

Guarnitura rosetta e bocchetta  $\varnothing$  50 mm a pressione.  
Door handle on  $\varnothing$  50 mm pressured fixed rose and escutcheon.

FINITURA FINISH	CR/CRS
--------------------	--------

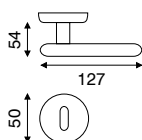

### Art. FI 3.0060 BIC

DK movimento in fibra con rosetta ovale 31x61 mm.  
DK nylon mechanism on oval rose 31x61 mm.

FINITURA FINISH	CR/CRS
--------------------	--------

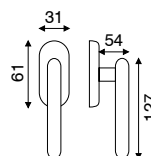

### Art. MA 3.0076 BIC

Guarnitura rosetta staccata e bocchetta quadra 45x45 mm a pressione.  
Door handle on 45x45 mm pressured unassembled rose and escutcheon.

FINITURA FINISH	CR/CRS
--------------------	--------

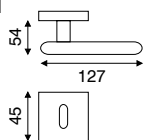

## SERIE ELEMENT



### Art. MA 2.9068

Guarnitura rosetta e bocchetta  $\varnothing$  50 mm a pressione.  
Door handle on  $\varnothing$  50 mm pressured fixed rose and escutcheon.

FINITURA FINISH	CRS	OTT
--------------------	-----	-----

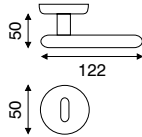

### Art. FI 2.9060

DK movimento in fibra con rosetta ovale 31x61 mm.  
DK nylon mechanism on oval rose 31x61 mm.

FINITURA FINISH	CRS	OTT
--------------------	-----	-----

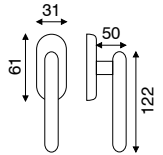

## SERIE FIVE



### Art. MA 2.0858

Guarnitura rosetta staccata e bocchetta  $\varnothing$  50 mm a pressione.  
Door handle on  $\varnothing$  50 mm pressured unassembled rose and escutcheon.

FINITURA FINISH	CRS	CR	OTT
--------------------	-----	----	-----

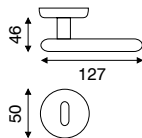

### Art. FI 2.0860

DK movimento in fibra con rosetta ovale 31x61 mm.  
DK nylon mechanism on oval rose 31x61 mm.

FINITURA FINISH	CRS	CR	OTT
--------------------	-----	----	-----

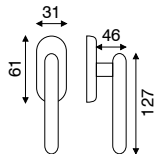

## SERIE MITO



### Art. MA 2.9968 Z

Guarnitura rosetta e bocchetta  $\varnothing$  50 mm a pressione.  
Door handle on  $\varnothing$  50 mm pressured fixed rose and escutcheon.

FINITURA FINISH	CRS	CR	OTT
--------------------	-----	----	-----

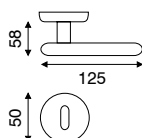

### Art. FI 2.9960 Z

DK movimento in fibra con rosetta ovale 31x61 mm.  
DK nylon mechanism on oval rose 31x61 mm.

FINITURA FINISH	CRS	CR	OTT
--------------------	-----	----	-----

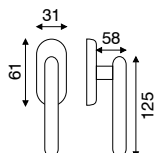



**Art. MA 3.2358**

Guarnitura rosetta staccata e bocchetta  $\varnothing$  50 mm a pressione.  
Door handle on  $\varnothing$  50 mm pressured unassembled rose and escutcheon.

FINITURA FINISH	CRS	CR	OTT
--------------------	-----	----	-----

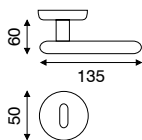

**Art. FI 3.2360**

DK movimento in fibra con rosetta ovale 31x61 mm.  
DK nylon mechanism on oval rose 31x61 mm.

FINITURA FINISH	CRS	CR	OTT
--------------------	-----	----	-----

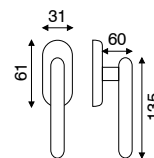

**Art. MA 2.1261**

Guarnitura rosetta e bocchetta  $\varnothing$  45 mm a pressione.  
Door handle on  $\varnothing$  45 mm pressured fixed rose and escutcheon.

FINITURA FINISH	CRS
--------------------	-----

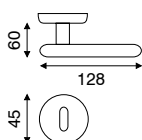

**Art. FI 2.1260**

DK movimento in fibra con rosetta ovale 31x61 mm.  
DK nylon mechanism on oval rose 31x61 mm.

FINITURA FINISH	CRS
--------------------	-----

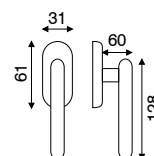



**Art. MA 2.8461**

Guarnitura rosetta e bocchetta ø 45 mm a pressione.  
Door handle on ø 45 mm pressured fixed rose and escutcheon.

FINITURA FINISH	CRS
--------------------	-----

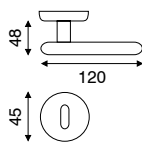

**Art. FI 2.8460**

DK movimento in fibra con rosetta ovale 31x61 mm.  
DK nylon mechanism on oval rose 31x61 mm.

FINITURA FINISH	CRS
--------------------	-----

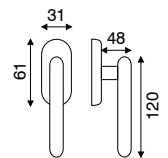

**Art. MA 2.8461 BIC**

Guarnitura rosetta e bocchetta ø 45 mm a pressione.  
Door handle on ø 45 mm pressured fixed rose and escutcheon.

FINITURA FINISH	CR/CRS
--------------------	--------

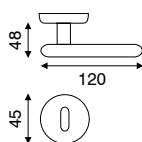

**Art. FI 2.8460 BIC**

DK movimento in fibra con rosetta ovale 31x61 mm.  
DK nylon mechanism on oval rose 31x61 mm.

FINITURA FINISH	CR/CRS
--------------------	--------

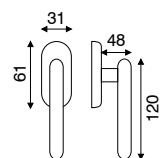

# SERIE TORRE



## Art. MA 2.7261

Guarnitura rosetta e bocchetta ø 45 mm a pressione.  
Door handle on ø 45 mm pressured fixed rose and escutcheon.

FINITURA FINISH	CRS
--------------------	-----

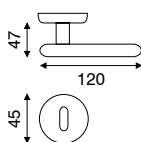

## Art. FI 2.7260

DK movimento in fibra con rosetta ovale 31x61 mm.  
DK nylon mechanism on oval rose 31x61 mm.

FINITURA FINISH	CRS
--------------------	-----

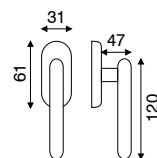

# SERIE TORRE BIC



## Art. MA 2.7261 BIC

Guarnitura rosetta e bocchetta ø 45 mm a pressione.  
Door handle on ø 45 mm pressured fixed rose and escutcheon.

FINITURA FINISH	CR/CRS
--------------------	--------

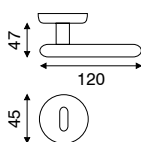

## Art. FI 2.7260 BIC

DK movimento in fibra con rosetta ovale 31x61 mm.  
DK nylon mechanism on oval rose 31x61 mm.

FINITURA FINISH	CR/CRS
--------------------	--------

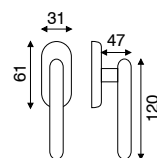



**Art. MA 2.9161**

Guarnitura rosetta e bocchetta  $\varnothing$  45 mm a pressione.  
Door handle on  $\varnothing$  45 mm pressured fixed rose and escutcheon.

FINITURA FINISH	CRS
--------------------	-----

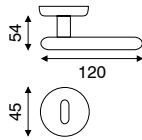

**Art. FI 2.9160**

DK movimento in fibra con rosetta ovale 31x61 mm.  
DK nylon mechanism on oval rose 31x61 mm.

FINITURA FINISH	CRS
--------------------	-----

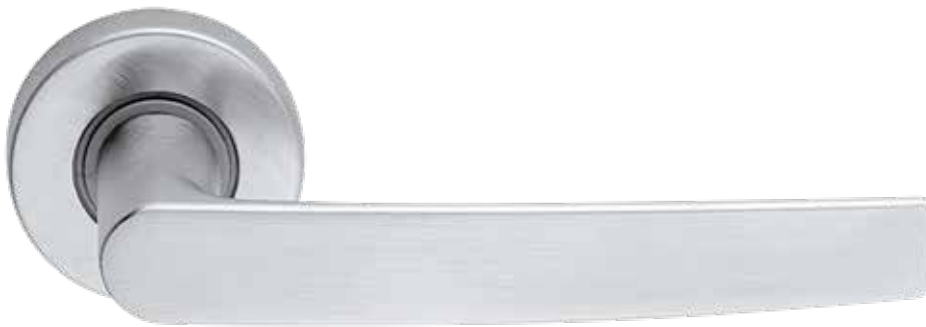
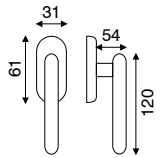

**Art. MA 2.8961**

Guarnitura rosetta e bocchetta  $\varnothing$  45 mm a pressione.  
Door handle on  $\varnothing$  45 mm pressured fixed rose and escutcheon.

FINITURA FINISH	CRS
--------------------	-----

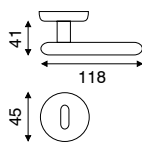

**Art. FI 2.8960**

DK movimento in fibra con rosetta ovale 31x61 mm.  
DK nylon mechanism on oval rose 31x61 mm.

FINITURA FINISH	CRS
--------------------	-----

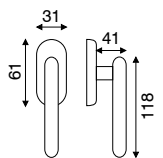

## SERIE VEGA



### Art. 1.1161

Guarnitura rosetta e bocchetta  $\varnothing$  45 mm a pressione.  
Door handle on  $\varnothing$  45 mm pressured fixed rose and escutcheon.

FINITURA FINISH	CRS	CR	OTT	OGR
--------------------	-----	----	-----	-----

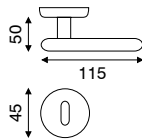

### Art. 4.1160

DK movimento in fibra con rosetta ovale 31x61 mm.  
DK nylon mechanism on oval rose 31x61 mm.

FINITURA FINISH	CRS	CR	OTT	OGR
--------------------	-----	----	-----	-----

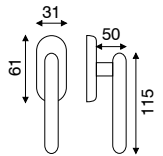

## SERIE VEGA PESANTE



### Art. 1.1161 PES

Guarnitura rosetta e bocchetta  $\varnothing$  45 mm a pressione.  
Door handle on  $\varnothing$  45 mm pressured fixed rose and escutcheon.

FINITURA FINISH	CRS	OTT
--------------------	-----	-----

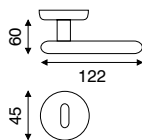

### Art. 4.1160 PES

DK movimento in fibra con rosetta ovale 31x61 mm.  
DK nylon mechanism on oval rose 31x61 mm.

FINITURA FINISH	CRS	OTT
--------------------	-----	-----

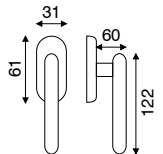

## SERIE KAROL



### Art. 1.9561

Guarnitura rosetta e bocchetta  $\varnothing$  45 mm a pressione.  
Door handle on  $\varnothing$  45 mm pressured fixed rose and escutcheon.

FINITURA FINISH	CRS	CR	OTT	OGR
--------------------	-----	----	-----	-----

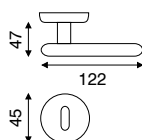

### Art. 4.9560

DK movimento in fibra con rosetta ovale 31x61 mm.  
DK nylon mechanism on oval rose 31x61 mm.

FINITURA FINISH	CRS	CR	OTT	OGR
--------------------	-----	----	-----	-----

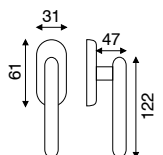

## SERIE GOCCIA



### Art. MA 2.2161

Guarnitura rosetta e bocchetta  $\varnothing$  45 mm a pressione.  
Door handle on  $\varnothing$  45 mm pressured fixed rose and escutcheon.

FINITURA FINISH OTT/SAT CR/CRS

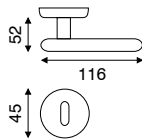

### Art. FI 2.2160

DK movimento in fibra con rosetta ovale 31x61 mm.  
DK nylon mechanism on oval rose 31x61 mm.

FINITURA FINISH OTT/SAT CR/CRS

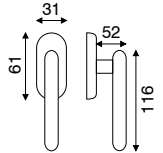

## SERIE CLASSIC

### Art. 1.2561

Guarnitura rosetta e bocchetta  $\varnothing$  45 mm a pressione.  
Door handle on  $\varnothing$  45 mm pressured fixed rose and escutcheon.

FINITURA FINISH OTT OGR

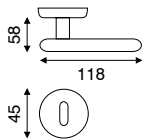

### Art. 4.2560

DK movimento in fibra con rosetta ovale 31x61 mm.  
DK nylon mechanism on oval rose 31x61 mm.

FINITURA FINISH OTT OGR

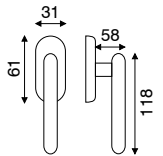

## SERIE GAUDEL

### Art. 1.2168

Guarnitura rosetta e bocchetta  $\varnothing$  50 mm a pressione.  
Door handle on  $\varnothing$  50 mm pressured fixed rose and escutcheon.

FINITURA FINISH CRS CR OTT OGR

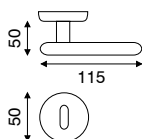

### Art. 4.2160

DK movimento in fibra con rosetta ovale 31x61 mm.  
DK nylon mechanism on oval rose 31x61 mm.

FINITURA FINISH CRS CR OTT OGR

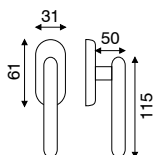



## SERIE GEA



### Art. 1.9661

Guarnitura rosetta e bocchetta  $\varnothing$  45 mm a pressione.

Door handle on  $\varnothing$  45 mm pressured fixed rose and escutcheon.

FINITURA FINISH	OTT	OGR
--------------------	-----	-----

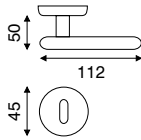

### Art. 4.9660

DK movimento in fibra con rosetta ovale 31x61 mm.

DK nylon mechanism on oval rose 31x61 mm.

FINITURA FINISH	OTT	OGR
--------------------	-----	-----

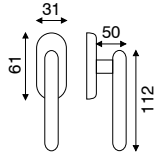

## SERIE EVA



### Art. 1.6361

Guarnitura rosetta e bocchetta  $\varnothing$  45 mm a pressione.

Door handle on  $\varnothing$  45 mm pressured fixed rose and escutcheon.

FINITURA FINISH	OTT	OGR
--------------------	-----	-----

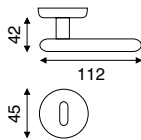

### Art. 4.6360

DK movimento in fibra con rosetta ovale 31x61 mm.

DK nylon mechanism on oval rose 31x61 mm.

FINITURA FINISH	OTT	OGR
--------------------	-----	-----

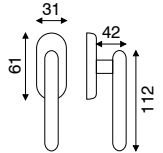

## SERIE GARDA



### Art. 1.4161

Guarnitura rosetta e bocchetta  $\varnothing$  45 mm a pressione.

Door handle on  $\varnothing$  45 mm pressured fixed rose and escutcheon.

FINITURA FINISH	OTT	OGR
--------------------	-----	-----

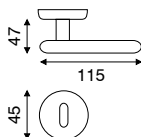

### Art. 4.4160

DK movimento in fibra con rosetta ovale 31x61 mm.

DK nylon mechanism on oval rose 31x61 mm.

FINITURA FINISH	OTT	OGR
--------------------	-----	-----

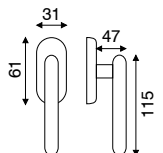





Ottali

LINEA

*ALLUMINIO*

NEW

# SERIE ALU 01

IMBALLO:  
MINIMO 10 PZ.  
TERMORETRAIBILE



## Art. MA 3.2651

Guarnitura rosetta staccata e bocchetta  $\varnothing$  45 mm a pressione.  
Door handle on  $\varnothing$  45 mm pressured unassembled rose and escutcheon.

FINITURA FINISH	CR/CRS
--------------------	--------

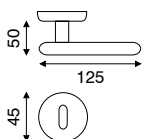

## Art. FI 3.2660

DK movimento in fibra con rosetta ovale 31x61 mm.  
DK nylon mechanism on oval rose 31x61 mm.

FINITURA FINISH	CR/CRS
--------------------	--------

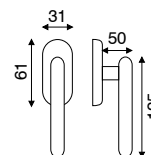

NEW

# SERIE KALU

IMBALLO:  
MINIMO 10 PZ.  
TERMORETRAIBILE



## Art. MA 3.2761

Guarnitura rosetta e bocchetta  $\varnothing$  45 mm a pressione.  
Door handle on  $\varnothing$  45 mm pressured fixed rose and escutcheon.

FINITURA FINISH	OLV	CRS	CR	OGR
--------------------	-----	-----	----	-----

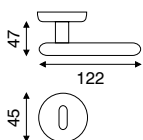

## Art. FI 3.2760

DK movimento in fibra con rosetta ovale 31x61 mm.  
DK nylon mechanism on oval rose 31x61 mm.

FINITURA FINISH	OLV	CRS	CR	OGR
--------------------	-----	-----	----	-----

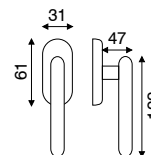

NEW

# SERIE ELLE A

IMBALLO:  
MINIMO 10 PZ.  
TERMORETRAIBILE



## Art. MA 2.8076 A

Guarnitura rosetta staccata e bocchetta quadra 50x50 mm a pressione.

Door handle on 50x50 mm pressured unassembled rose and escutcheon.

FINITURA FINISH	ALL. CRS	ALL. NR OP
--------------------	-------------	---------------

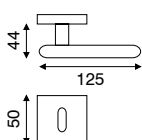

## Art. FI 2.8070 A

DK movimento in fibra con rosetta rettangolare 31x61 mm.

DK nylon mechanism on rectangular rose 31x61 mm.

FINITURA FINISH	ALL. CRS	ALL. NR OP
--------------------	-------------	---------------

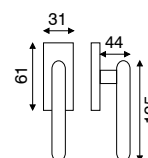

## SERIE OMEGA

**IMBALLO:**  
MINIMO 10 PZ.  
TERMORETRAIBILE



### Art. MA 2.1968

Guarnitura rosetta e bocchetta  
ø 50 mm a pressione.  
Door handle on ø 50 mm pressured  
rose and escutcheon.

FINITURA FINISH	ALL. BR	ALL. ARG

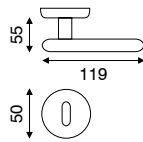

### Art. MA 2.1910

Guarnitura con placca Alluminio.  
Door handle on plate Alluminio.

FINITURA FINISH	ALL. BR	ALL. ARG

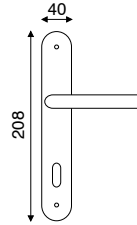

### Art. FI 2.1960

DK movimento in fibra con rosetta  
ovale 31x61 mm.  
DK nylon mechanism on oval rose  
31x61 mm.

FINITURA FINISH	ALL. BR	ALL. ARG

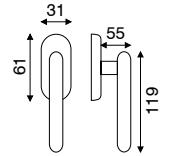

## SERIE THEA

**IMBALLO:**  
MINIMO 10 PZ.  
TERMORETRAIBILE



### Art. 1.6468

Guarnitura rosetta e bocchetta  
ø 50 mm a pressione.  
Door handle on ø 50 mm pressured  
rose and escutcheon.

FINITURA FINISH	ALL. BR	ALL. ARG

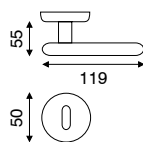

### Art. 1.6410

Guarnitura con placca Alluminio.  
Door handle on plate Alluminio.

FINITURA FINISH	ALL. BR	ALL. ARG

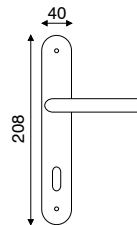

### Art. 4.6460

DK movimento in fibra con rosetta  
rettangolare 31x61 mm.  
DK nylon mechanism on rectangular  
rose 31x61 mm.

FINITURA FINISH	ALL. BR	ALL. ARG

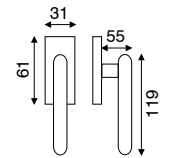

## SERIE VENUS/SEDNA

**IMBALLO:**  
MINIMO 10 PZ.  
TERMORETRAIBILE



### Art. 1.9968 A

Guarnitura rosetta e bocchetta  
ø 50 mm a pressione.  
Door handle on ø 50 mm pressured  
rose and escutcheon.

FINITURA FINISH	ALL. BR	ALL. ARG

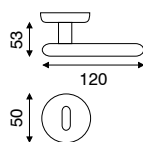

### Art. 1.9910 A

Guarnitura con placca Alluminio.  
Door handle on plate Alluminio.

FINITURA FINISH	ALL. BR	ALL. ARG

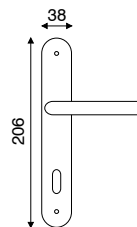

### Art. 4.9960 A

DK movimento in fibra con rosetta  
ovale 31x61 mm.  
DK nylon mechanism on oval rose  
31x61 mm.

FINITURA FINISH	ALL. BR	ALL. ARG

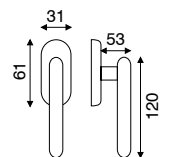

## SERIE JAPAN

**IMBALLO:**  
MINIMO 10 PZ.  
TERMORETRAIBILE



### Art. MA 2.8868

Guarnitura rosetta e bocchetta ø 50 mm a pressione.

Door handle on ø 50 mm pressured rose and escutcheon.

FINITURA FINISH	ALL. BR	ALL. ARG
--------------------	------------	-------------

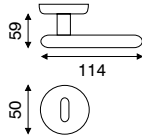

### Art. FI 2.8860

DK movimento in fibra con rosetta rettangolare 31x61 mm.

DK nylon mechanism on rectangular rose 31x61 mm.

FINITURA FINISH	ALL. BR	ALL. ARG
--------------------	------------	-------------

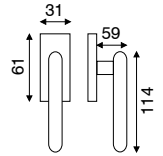

## SERIE MITO A

**IMBALLO:**  
MINIMO 10 PZ.  
TERMORETRAIBILE



### Art. MA 2.9968 A

Guarnitura rosetta e bocchetta ø 50 mm a pressione.

Door handle on ø 50 mm pressured rose and escutcheon.

FINITURA FINISH	ALL. BR	ALL. ARG
--------------------	------------	-------------

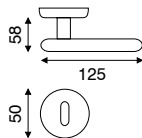

### Art. FI 2.9960 A

DK movimento in fibra con rosetta ovale 31x61 mm.

DK nylon mechanism on oval rose 31x61 mm.

FINITURA FINISH	ALL. BR	ALL. ARG
--------------------	------------	-------------

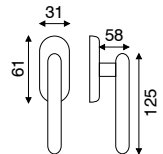

## SERIE BERGAMO

**IMBALLO:**  
MINIMO 10 PZ.  
TERMORETRAIBILE



### Art. MA 2.0168

Guarnitura rosetta e bocchetta ø 50 mm a pressione.

Door handle on ø 50 mm pressured rose and escutcheon.

FINITURA FINISH	ALL. BR	ALL. ARG
--------------------	------------	-------------

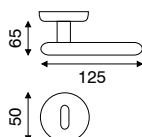

### Art. FI 2.0160

DK movimento in fibra con rosetta rettangolare 31x61 mm.

DK nylon mechanism on rectangular rose 31x61 mm.

FINITURA FINISH	ALL. BR	ALL. ARG
--------------------	------------	-------------

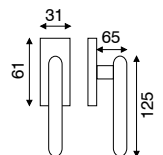

## SERIE TUBOLARE

**IMBALLO:**  
MINIMO 10 PZ.  
TERMORETRAIBILE



### Art. MA 2.5268

Guarnitura rosetta e bocchetta ø 50 mm a pressione.  
Door handle on ø 50 mm pressured rose and escutcheon.

FINITURA FINISH	ALL. BR	ALL. ARG
--------------------	------------	-------------

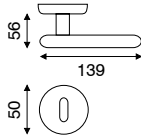

### Art. FI 2.5260

DK movimento in fibra con rosetta ovale 31x61 mm.  
DK nylon mechanism on oval rose 31x61 mm.

FINITURA FINISH	ALL. BR	ALL. ARG
--------------------	------------	-------------

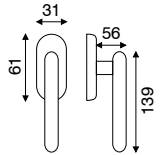

## SERIE ACCA

**IMBALLO:**  
MINIMO 10 PZ.  
TERMORETRAIBILE



### Art. MA 2.9668

Guarnitura rosetta e bocchetta ø 50 mm a pressione.  
Door handle on ø 50 mm pressured rose and escutcheon.

FINITURA FINISH	ALL. BR	ALL. ARG
--------------------	------------	-------------

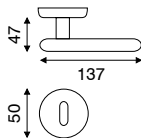

### Art. FI 2.9660

DK movimento in fibra con rosetta ovale 31x61 mm.  
DK nylon mechanism on oval rose 31x61 mm.

FINITURA FINISH	ALL. BR	ALL. ARG
--------------------	------------	-------------

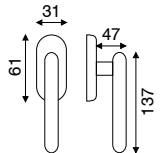

## SERIE MILANO

**IMBALLO:**  
MINIMO 10 PZ.  
TERMORETRAIBILE



### Art. 1.5768

Guarnitura rosetta e bocchetta ø 50 mm a pressione.  
Door handle on ø 50 mm pressured rose and escutcheon.

FINITURA FINISH	ALL. BR	ALL. ARG
--------------------	------------	-------------

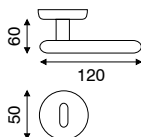

### Art. 4.5760

DK movimento in fibra con rosetta rettangolare 31x61 mm.  
DK nylon mechanism on rectangular rose 31x61 mm.

FINITURA FINISH	ALL. BR	ALL. ARG
--------------------	------------	-------------

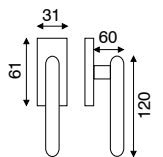



## SERIE OTTOCENTO

**IMBALLO:**  
MINIMO 10 PZ.  
TERMORETRAIBILE



### Art. 1.3668

Guarnitura rosetta e bocchetta ø 50 mm a pressione.

Door handle on ø 50 mm pressured rose and escutcheon.

FINITURA FINISH	ALL. BR	ALL. ARG
--------------------	------------	-------------

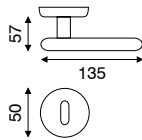

### Art. 4.3660

DK movimento in fibra con rosetta ovale 31x61 mm.

DK nylon mechanism on oval rose 31x61 mm.

FINITURA FINISH	ALL. BR	ALL. ARG
--------------------	------------	-------------

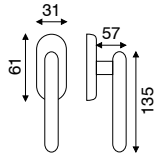

## SERIE USA

**IMBALLO:**  
MINIMO 10 PZ.  
TERMORETRAIBILE

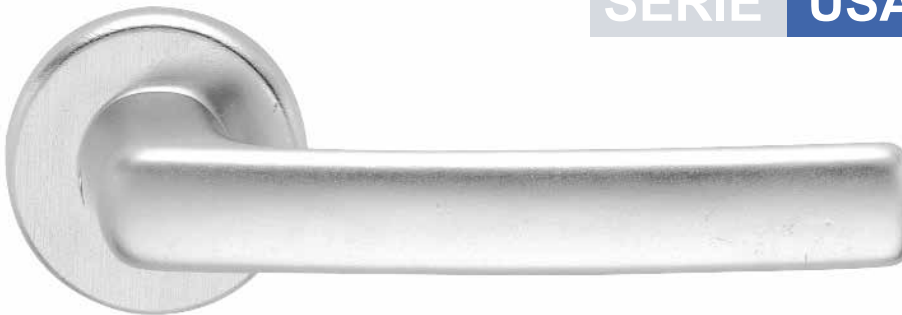

### Art. MA 3.2568

Guarnitura rosetta e bocchetta ø 50 mm a pressione.

Door handle on ø 50 mm pressured rose and escutcheon.

FINITURA FINISH	ALL. BR	ALL. ARG
--------------------	------------	-------------

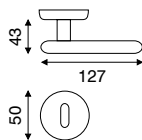

### Art. FI 3.2560

DK movimento in fibra con rosetta ovale 31x61 mm.

DK nylon mechanism on oval rose 31x61 mm.

FINITURA FINISH	ALL. BR	ALL. ARG
--------------------	------------	-------------

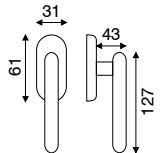

## SERIE ACAPULCO



### Art. MA 2.0974

Guarnitura rosetta staccata e bocchetta quadra 50x50 mm a pressione.

Door handle on 50x50 mm pressured unassembled rose and escutcheon.

FINITURA FINISH	ALL. BR	ALL. ARG
--------------------	------------	-------------

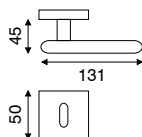

### Art. FI 2.0970

DK movimento in fibra con rosetta rettangolare 31x61 mm.

DK nylon mechanism on rectangular rose 31x61 mm.

FINITURA FINISH	ALL. BR	ALL. ARG
--------------------	------------	-------------

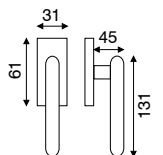



**Art. 3.6400**

Pomolo Thea fisso ø 70 mm - rosetta ø 50 mm a pressione fisso con sottorosone.  
Knob Thea ø 70 mm - ø 50 mm pressured fixed rose with fixed pivot.

FINITURA IMBALLO	ALL. BR 10	ALL. ARG 10
---------------------	---------------	----------------



**Art. 3.6450**

Pomolo Omega fisso ø 60 mm - rosetta ø 50 mm a pressione fisso con sottorosone.  
Knob Omega ø 60 mm - ø 50 mm pressured fixed rose with fixed pivot.

FINITURA IMBALLO	ALL. BR 10	ALL. ARG 10
---------------------	---------------	----------------



**Art. 3.6500**

Pomolo Triangolo fisso con sottorosone rosetta ø 50 mm a pressione.  
Knob Triangolo ø 50 mm pressured fixed rose with fixed pivot.

FINITURA IMBALLO	ALL. BR 10	ALL. ARG 10
---------------------	---------------	----------------

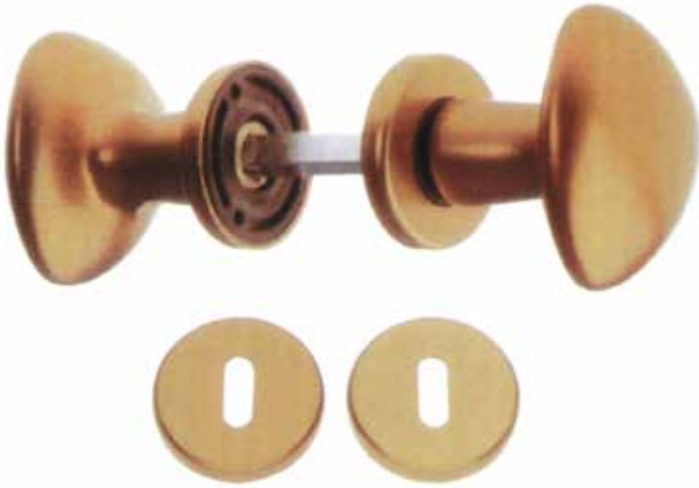

### Art. 1.9130

Guarnitura Triangolo rosetta e bocchetta ø 50 mm a pressione.  
Door handle Triangolo on ø 50 mm pressured fixed rose and escutcheon.

FINITURA IMBALLO	ALL. BR 1	ALL. ARG 1
---------------------	--------------	---------------



### Art. 1.9140

Guarnitura Uovo rosetta e bocchetta ø 50 mm a pressione.  
Door handle Uovo on ø 50 mm pressured fixed rose and escutcheon.

FINITURA IMBALLO	ALL. BR 1	ALL. ARG 1
---------------------	--------------	---------------



### Art. 3.2890/LO

Coppia nottolino wc con rosetta ø 50 mm a pressione.  
Wc set on ø 50 mm pressured fixed rose.

FINITURA IMBALLO	ALL. BR 10	ALL. ARG 10
---------------------	---------------	----------------



### Art. 2.9170

Bocchetta ø 50 mm a pressione con foro asola.  
Pressured fixed escutcheon ø 50 mm - key hole.

FINITURA IMBALLO	ALL. BR 10	ALL. ARG 10
---------------------	---------------	----------------



### Art. 2.9170.18

Bocchetta ø 50 mm a pressione con foro yale.  
Pressured fixed escutcheon ø 50 mm - yale hole.

FINITURA IMBALLO	ALL. BR 10	ALL. ARG 10
---------------------	---------------	----------------



# ottali



LINEA

*INOX*

## SERIE OLARIX



### Art. 1.4868

Guarnitura rosetta e bocchetta  $\varnothing$  50 mm a pressione.  
Door handle on  $\varnothing$  50 mm pressured fixed rose and escutcheon.

FINITURA FINISH ACC. SAT

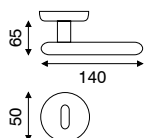

### Art. 4.4860

DK movimento in fibra con rosetta ovale 31x61 mm.  
DK nylon mechanism on oval rose 31x61 mm.

FINITURA FINISH ACC. SAT

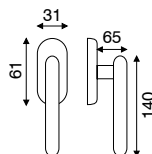

### Art. 1.4863

Guarnitura rosetta e bocchetta ovale 31x61 mm.  
Door handle on oval rose and escutcheon 31x61 mm.

FINITURA FINISH ACC. SAT

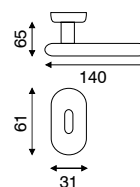

## SERIE OLARIX XL 200



### Art. MA 2.4068

Guarnitura rosetta e bocchetta  $\varnothing$  50 mm a pressione.  
Door handle on  $\varnothing$  50 mm pressured fixed rose and escutcheon.

FINITURA FINISH ACC. SAT

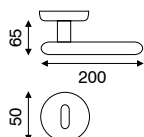

## SERIE CAPRIX



### Art. 1.8368

Guarnitura rosetta e bocchetta  $\varnothing$  50 mm a pressione.  
Door handle on  $\varnothing$  50 mm pressured fixed rose and escutcheon.

FINITURA FINISH ACC. SAT

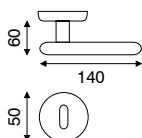

### Art. 4.8360

DK movimento in fibra con rosetta ovale 31x61 mm.  
DK nylon mechanism on oval rose 31x61 mm.

FINITURA FINISH ACC. SAT

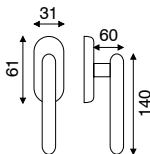

### Art. 1.8363

Guarnitura rosetta e bocchetta ovale 31x61 mm.  
Door handle on oval rose and escutcheon 31x61 mm.

FINITURA FINISH ACC. SAT

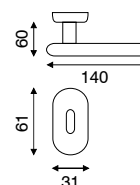

## SERIE NOVANTA



### Art. MA 2.1468

Guarnitura rosetta e bocchetta  $\varnothing$  50 mm a pressione.  
Door handle on  $\varnothing$  50 mm pressured fixed rose and escutcheon.

FINITURA FINISH ACC. SAT

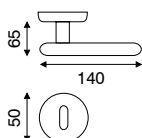

### Art. FI 2.1460

DK movimento in fibra con rosetta ovale 31x61 mm.  
DK nylon mechanism on oval rose 31x61 mm.

FINITURA FINISH ACC. SAT

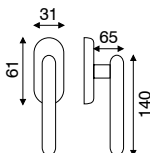

### Art. MA 2.1463

Guarnitura rosetta e bocchetta ovale 31x61 mm.  
Door handle on oval rose and escutcheon 31x61 mm.

FINITURA FINISH ACC. SAT

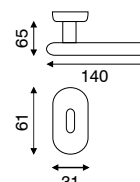



**Art. MA 2.0368**

Guarnitura rosetta e bocchetta ø 50 mm a pressione.  
Door handle on ø 50 mm pressured fixed rose and escutcheon.

FINITURA FINISH	ACC. SAT
--------------------	----------

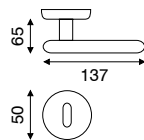

**Art. FI 2.0360**

DK movimento in fibra con rosetta ovale 31x61 mm.  
DK nylon mechanism on oval rose 31x61 mm.

FINITURA FINISH	ACC. SAT
--------------------	----------

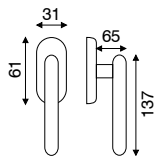

**Art. MA 2.8774**

Guarnitura rosetta staccata e bocchetta quadra 50x50 mm a pressione.  
Door handle on 50x50 mm pressured unassembled rose and escutcheon.

FINITURA FINISH	ACC. SAT
--------------------	----------

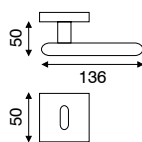

**Art. FI 2.8770**

DK movimento in fibra con rosetta rettangolare 31x61 mm.  
DK nylon mechanism on rectangular rose 31x61 mm.

FINITURA FINISH	ACC. SAT
--------------------	----------

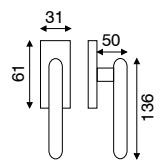



## SERIE CORUS



### Art. MA 2.3668

Guarnitura rosetta e bocchetta  $\varnothing$  50 mm a pressione.  
Door handle on  $\varnothing$  50 mm pressured fixed rose and escutcheon.

FINITURA ACC. LUC/ACC. SAT  
FINISH

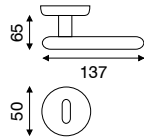

### Art. FI 2.3660

DK movimento in fibra con rosetta ovale 31x61 mm.  
DK nylon mechanism on oval rose 31x61 mm.

FINITURA ACC. LUC/ACC. SAT  
FINISH

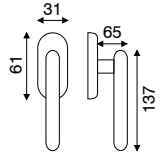

## SERIE ACCESSORI INOX



### Art. 2.9150

Bocchetta  $\varnothing$  50 mm a pressione con foro asola AISI 304.  
Pressured fixed escutcheon  $\varnothing$  50 mm - key hole AISI 304.

FINITURA ACC. SAT  
IMBALLO 12



### Art. 2.9150.18

Bocchetta  $\varnothing$  50 mm a pressione con foro yale AISI 304.  
Pressured fixed escutcheon  $\varnothing$  50 mm - yale hole AISI 304.

FINITURA ACC. SAT  
IMBALLO 12



### Art. 2.9155

Bocchetta ovale 61x31 mm a pressione con foro asola AISI 304.  
Oval pressured fixed escutcheon 61x31 mm - key hole AISI 304.

FINITURA ACC. SAT  
IMBALLO 12



### Art. 2.9155.18

Bocchetta ovale 61x31 mm a pressione con foro yale AISI 304.  
Oval pressured fixed escutcheon 61x31 mm - yale hole AISI 304.

FINITURA ACC. SAT  
IMBALLO 12



### Art. 3.2870/LO

Coppia nottolino wc con visualizzatore l/o con rosetta  $\varnothing$  50 mm a pressione AISI 304.  
Wc set whit display free/busy on  $\varnothing$  50 mm pressured fixed rose AISI 304.

FINITURA ACC. SAT  
IMBALLO 6



### Art. 3.2870

Coppia nottolino wc con rosetta  $\varnothing$  50 mm a pressione AISI 304.  
Wc set on  $\varnothing$  50 mm pressured fixed rose AISI 304.

FINITURA ACC. SAT  
IMBALLO 6





ottali

LINEA

*OTTONE*



### Art. MA 3.1582

Guarnitura rosetta e bocchetta  $\varnothing$  55 mm ad avvitare.

Door handle on  $\varnothing$  55 mm screwed " rose and escutcheon.

FINITURA FINISH	OLV	OGR OP
--------------------	-----	-----------

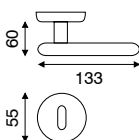

### Art. FI 3.1560

DK movimento in fibra con rosetta ovale 31x61 mm.

DK nylon mechanism on oval rose 31x61 mm.

FINITURA FINISH	OLV	OGR OP
--------------------	-----	-----------

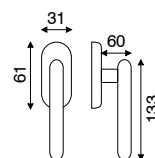

**Art. MA 2.0669**

Guarnitura rosetta e bocchetta "con bordo"  $\varnothing$  50 mm ad avvitare.

Door handle on  $\varnothing$  50 mm screwed "edged" rose and escutcheon.

FINITURA FINISH	OLV	OGR OP
--------------------	-----	-----------

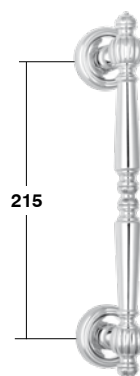
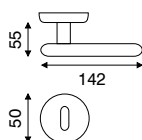

215

**Art. FI 2.0660**

DK movimento in fibra con rosetta ovale 31x61 mm.

DK nylon mechanism on oval rose 31x61 mm.

FINITURA FINISH	OLV	OGR OP
--------------------	-----	-----------

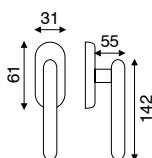
**Art. 3.5420**

Maniglione Apple int. 215 mm.

Apple pull handle int. 215 mm.

FINITURA IMBALLO	OLV 2	OGR OP 2
---------------------	----------	----------------

## SERIE MARIBOR



### Art. MA 2.7770

Guarnitura rosetta e bocchetta "bombata" ø 50 mm ad avvitare.  
Door handle on ø 50 mm screwed "curved" rose and escutcheon.

FINITURA FINISH OLV ORO ANT

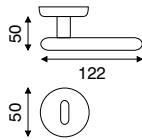

### Art. FI 2.7760

DK movimento in fibra con rosetta ovale 31x61 mm.  
DK nylon mechanism on oval rose 31x61 mm.

FINITURA FINISH OLV ORO ANT

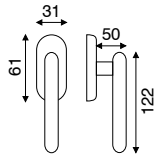

## SERIE BERNINI



### Art. MA 2.8378

Guarnitura rosetta e bocchetta "decò" ø 60 mm ad avvitare.  
Door handle on ø 60 mm screwed "decò" rose and escutcheon.

FINITURA FINISH OLV ORO ANT

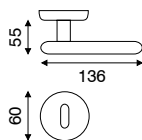

### Art. FI 2.8360

DK movimento in fibra con rosetta ovale 31x61 mm.  
DK nylon mechanism on oval rose 31x61 mm.

FINITURA FINISH OLV ORO ANT

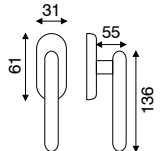

## SERIE ATTIK



### Art. MA 2.8578

Guarnitura rosetta e bocchetta "decò" ø 60 mm ad avvitare.  
Door handle on ø 60 mm screwed "decò" rose and escutcheon.

FINITURA FINISH OLV ORO ANT

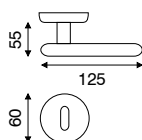

### Art. FI 2.8560

DK movimento in fibra con rosetta ovale 31x61 mm.  
DK nylon mechanism on oval rose 31x61 mm.

FINITURA FINISH OLV ORO ANT

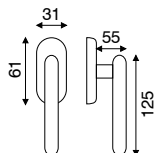

## SERIE VIENNA



### Art. MA 2.3369

Guarnitura rosetta e bocchetta "con bordo"  $\varnothing$  50 mm ad avvitare.  
Door handle on  $\varnothing$  50 mm screwed "edged" rose and escutcheon.

FINITURA FINISH ORO ANT ANT BL

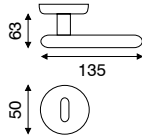

### Art. FI 2.3360

DK movimento in fibra con rosetta ovale 31x61 mm.  
DK nylon mechanism on oval rose 31x61 mm.

FINITURA FINISH ORO ANT ANT BL

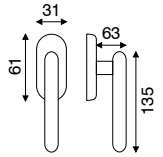

## SERIE ARCADIA



### Art. MA 2.5570

Guarnitura rosetta e bocchetta "bombata"  $\varnothing$  50 mm ad avvitare.  
Door handle on  $\varnothing$  50 mm screwed "curved" rose and escutcheon.

FINITURA FINISH ORO ANT ANT BL

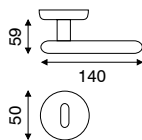

### Art. FI 2.5560

DK movimento in fibra con rosetta ovale 31x61 mm.  
DK nylon mechanism on oval rose 31x61 mm.

FINITURA FINISH ORO ANT ANT BL

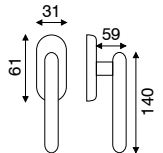

## SERIE GOTICA



### Art. MA 2.6669

Guarnitura rosetta e bocchetta "con bordo"  $\varnothing$  50 mm ad avvitare.  
Door handle on  $\varnothing$  50 mm screwed "edged" rose and escutcheon.

FINITURA FINISH ORO ANT ANT BL

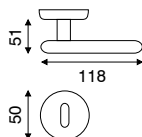

### Art. FI 2.6660

DK movimento in fibra con rosetta ovale 31x61 mm.  
DK nylon mechanism on oval rose 31x61 mm.

FINITURA FINISH ORO ANT ANT BL

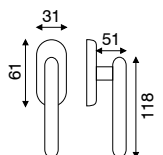

## SERIE BREMA



### Art. MA 2.5969

Guarnitura rosetta e bocchetta "con bordo" ø 50 mm ad avvitare.  
Door handle on ø 50 mm screwed "edged" rose and escutcheon.

FINITURA FINISH	OLV	ORO ANT
--------------------	-----	---------

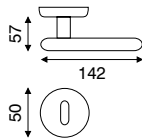

### Art. FI 2.5960

DK movimento in fibra con rosetta ovale 31x61 mm.  
DK nylon mechanism on oval rose 31x61 mm.

FINITURA FINISH	OLV	ORO ANT
--------------------	-----	---------

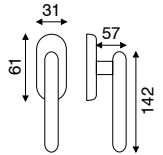

## SERIE ASA



### Art. MA 2.7361

Guarnitura rosetta e bocchetta ø 45 mm a pressione.  
Door handle on ø 45 mm pressured fixed rose and escutcheon.

FINITURA FINISH	OLV	OGR	CRS
--------------------	-----	-----	-----

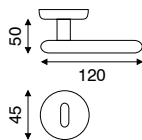

### Art. FI 2.7360

DK movimento in fibra con rosetta ovale 31x61 mm.  
DK nylon mechanism on oval rose 31x61 mm.

FINITURA FINISH	OLV	OGR	CRS
--------------------	-----	-----	-----

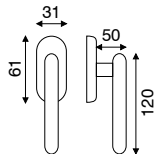

## SERIE PENDENTE



### Art. 1.6662

Guarnitura rosetta e bocchetta "artistica" ø 45 mm viti a vista s/molla.  
Door handle on ø 45 mm "artistic" rose and escutcheon w/out spring.

FINITURA FINISH	OLV	OGR
--------------------	-----	-----

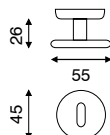

### Art. 1.6619

Guarnitura "pendente" su placca "stampata" "19".  
Door handle on "molded" plate "19".

FINITURA FINISH	OLV	OGR
--------------------	-----	-----

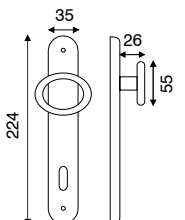



## SERIE BAROCCO



### Art. 1.5962

Guarnitura rosetta e bocchetta  $\varnothing$  45 mm viti a vista s/molla.  
Door handle on  $\varnothing$  45 mm rose and escutcheon w/out spring.

FINITURA FINISH BR

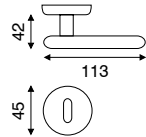

### Art. 1.5910

Guarnitura con placca.  
Door handle on plate.

FINITURA FINISH BR

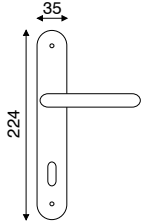

### Art. 1.2890

Guarnitura rosetta e bocchetta stile 40x81 mm.  
Door handle on rose and escutcheon 40x81 mm.

FINITURA FINISH OF

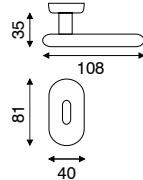

## SERIE FLORA



### Art. 1.2810

Guarnitura con placca.  
Door handle on plate.

FINITURA FINISH OF

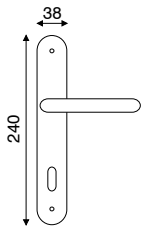

### Art. 1.9461

Guarnitura rosetta e bocchetta  $\varnothing$  45 mm a pressione.  
Door handle on  $\varnothing$  45 mm pressured fixed rose and escutcheon.

FINITURA FINISH OGR

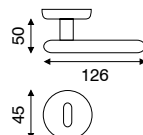

## SERIE ANGY



### Art. 1.9410

Guarnitura con placca.  
Door handle on plate.

FINITURA FINISH OGR

€

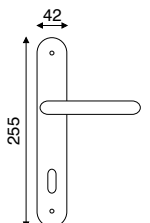

## SERIE POLO



### Art. 1.4060

Guarnitura rosetta e bocchetta  $\varnothing$  50 mm ad avvitare.  
Door handle on  $\varnothing$  50 mm screwed rose and escutcheon.

FINITURA FINISH	OLV	OGR	CRS

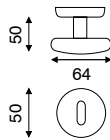

### Art. 4.4060

DK movimento in fibra con rosetta ovale 31x61 mm.  
DK nylon mechanism on oval rose 31x61 mm.

FINITURA FINISH	OLV	OGR	CRS

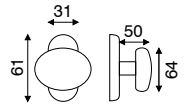

## SERIE SILVER

### Art. MA 2.9760

Guarnitura rosetta e bocchetta  $\varnothing$  50 mm ad avvitare.  
Door handle on  $\varnothing$  50 mm screwed rose and escutcheon.

FINITURA FINISH	OLV	OGR	CRS

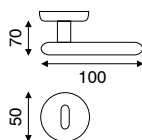

### Art. FI 2.9760

DK movimento in fibra con rosetta ovale 31x61 mm.  
DK nylon mechanism on oval rose 31x61 mm.

FINITURA FINISH	OLV	OGR	CRS

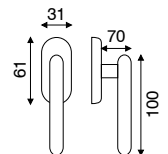

### Art. 1.7270

Guarnitura rosetta e bocchetta "bombata"  $\varnothing$  50 mm ad avvitare.  
Door handle on  $\varnothing$  50 mm screwed "curved" rose and escutcheon.

FINITURA FINISH	OLV	OGR	CRS

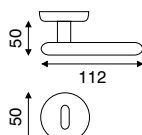

### Art. 4.7260

DK movimento in fibra con rosetta ovale 31x61 mm.  
DK nylon mechanism on oval rose 31x61 mm.

FINITURA FINISH	OLV	OGR	CRS

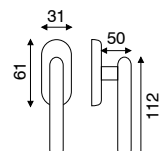

## SERIE UOVO



### Art. 1.5261

Guarnitura rosetta e bocchetta  $\varnothing$  45 mm a pressione.  
Door handle on  $\varnothing$  45 mm pressured fixed rose and escutcheon.

FINITURA FINISH	OLV	OGR	CRS

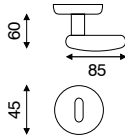

### Art. 4.5260

DK movimento in fibra con rosetta ovale 31x61 mm.  
DK nylon mechanism on oval rose 31x61 mm.

FINITURA FINISH	OLV	OGR	CRS

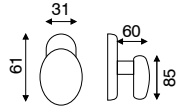

## SERIE RIVA

### Art. MA 2.7461

Guarnitura rosetta e bocchetta  $\varnothing$  45 mm a pressione.  
Door handle on  $\varnothing$  45 mm pressured fixed rose and escutcheon.

FINITURA FINISH	OLV	OGR	CRS

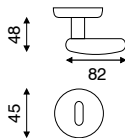

### Art. FI 2.7460

DK movimento in fibra con rosetta ovale 31x61 mm.  
DK nylon mechanism on oval rose 31x61 mm.

FINITURA FINISH	OLV	OGR	CRS

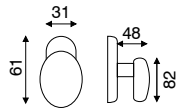

## SERIE VIOLA

### Art. MA 3.1458

Guarnitura rosetta staccata e bocchetta  $\varnothing$  50 mm a pressione.  
Door handle on  $\varnothing$  50 mm pressured unassembled rose and escutcheon.

FINITURA FINISH	OLV	OGR	CRS

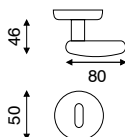

### Art. FI 3.1460

DK movimento in fibra con rosetta ovale 31x61 mm.  
DK nylon mechanism on oval rose 31x61 mm.

FINITURA FINISH	OLV	OGR	CRS

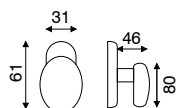

## SERIE RICCIO



### Art. 1.3569

Guarnitura rosetta e bocchetta "con bordo" ø 50 mm ad avvitare.  
Door handle on ø 50 mm screwed "edged" rose and escutcheon.

FINITURA FINISH	OLV	ORO ANT
--------------------	-----	---------

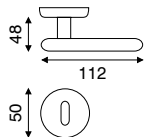

### Art. 4.3560

DK movimento in fibra con rosetta ovale 31x61 mm.  
DK nylon mechanism on oval rose 31x61 mm.

FINITURA FINISH	OLV	ORO ANT
--------------------	-----	---------

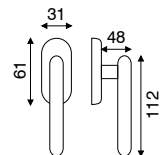

## SERIE VENEZIA



### Art. 1.2961

Guarnitura rosetta e bocchetta ø 45 mm a pressione.  
Door handle on ø 45 mm pressured fixed rose and escutcheon.

FINITURA FINISH	OLV	ANT BL
--------------------	-----	--------

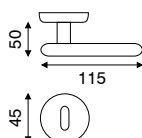

### Art. 4.2960

DK movimento in fibra con rosetta ovale 31x61 mm.  
DK nylon mechanism on oval rose 31x61 mm.

FINITURA FINISH	OLV	ANT BL
--------------------	-----	--------

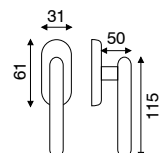

## SERIE CORINNE



### Art. 1.3761

Guarnitura rosetta e bocchetta  $\varnothing$  45 mm a pressione.

Door handle on  $\varnothing$  45 mm pressured fixed rose and escutcheon.

FINITURA FINISH	OLV	ANT BL

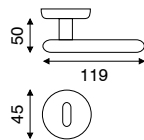

### Art. 4.3760

DK movimento in fibra con rosetta ovale 31x61 mm.

DK nylon mechanism on oval rose 31x61 mm.

FINITURA FINISH	OLV	ANT BL

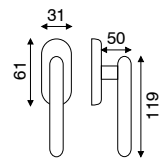

## SERIE VENERE



### Art. 1.7161

Guarnitura rosetta e bocchetta  $\varnothing$  45 mm a pressione.

Door handle on  $\varnothing$  45 mm pressured fixed rose and escutcheon.

FINITURA FINISH	OLV	OGR	CRS

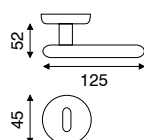

### Art. 4.7160

DK movimento in fibra con rosetta ovale 31x61 mm.

DK nylon mechanism on oval rose 31x61 mm.

FINITURA FINISH	OLV	OGR	CRS

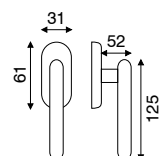

## SERIE MALAGA



### Art. 1.3361

Guarnitura rosetta e bocchetta  $\varnothing$  45 mm a pressione.

Door handle on  $\varnothing$  45 mm pressured fixed rose and escutcheon.

FINITURA FINISH	OLV	OGR
--------------------	-----	-----

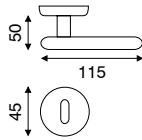

### Art. 4.3360

DK movimento in fibra con rosetta ovale 31x61 mm.

DK nylon mechanism on oval rose 31x61 mm.

FINITURA FINISH	OLV	OGR
--------------------	-----	-----

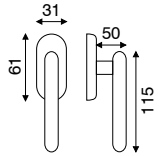

## SERIE TOSCANA



### Art. 1.2762

Guarnitura rosetta e bocchetta "artistica"  $\varnothing$  45 mm viti a vista s/molla.

Door handle on  $\varnothing$  45 mm "artistic" rose and escutcheon w/out spring.

FINITURA FINISH	OLV	ORO ANT
--------------------	-----	---------

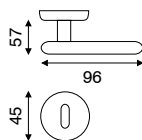

### Art. 4.2760

DK movimento in fibra con rosetta ovale 31x61 mm.

DK nylon mechanism on oval rose 31x61 mm.

FINITURA FINISH	OLV	ORO ANT
--------------------	-----	---------

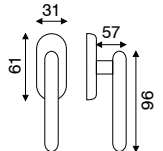

## SERIE LUCCA



### Art. 1.4762

Guarnitura rosetta e bocchetta "artistica"  $\varnothing$  45 mm viti a vista s/molla.

Door handle on  $\varnothing$  45 mm "artistic" rose and escutcheon w/out spring.

FINITURA FINISH	OLV	ORO ANT
--------------------	-----	---------

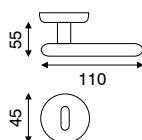

### Art. 4.4760

DK movimento in fibra con rosetta ovale 31x61 mm.

DK nylon mechanism on oval rose 31x61 mm.

FINITURA FINISH	OLV	ORO ANT
--------------------	-----	---------

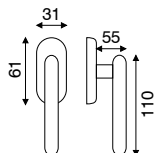

## SERIE ALTWIEN



### Art. 1.1361

Guarnitura rosetta e bocchetta  $\varnothing$  45 mm a pressione.  
Door handle on  $\varnothing$  45 mm pressured fixed rose and escutcheon.

FINITURA FINISH	OLV	CRS	ORO ANT
--------------------	-----	-----	---------

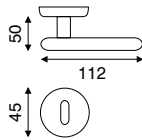

### Art. 4.1360

DK movimento in fibra con rosetta ovale 31x61 mm.  
DK nylon mechanism on oval rose 31x61 mm.

FINITURA FINISH	OLV	CRS	ORO ANT
--------------------	-----	-----	---------

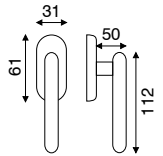

## SERIE ELEGANT



### Art. 1.6761

Guarnitura rosetta e bocchetta  $\varnothing$  45 mm a pressione.  
Door handle on  $\varnothing$  45 mm pressured fixed rose and escutcheon.

FINITURA FINISH	OLV	CRS
--------------------	-----	-----

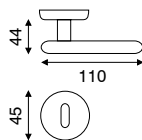

### Art. 4.6760

DK movimento in fibra con rosetta ovale 31x61 mm.  
DK nylon mechanism on oval rose 31x61 mm.

FINITURA FINISH	OLV	CRS
--------------------	-----	-----

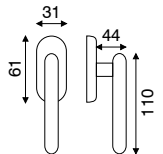

## SERIE SILVIA



### Art. 1.2061

Guarnitura rosetta e bocchetta  $\varnothing$  45 mm a pressione.  
Door handle on  $\varnothing$  45 mm pressured fixed rose and escutcheon.

FINITURA FINISH	OLV	OGR
--------------------	-----	-----

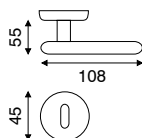

### Art. 4.2060

DK movimento in fibra con rosetta ovale 31x61 mm.  
DK nylon mechanism on oval rose 31x61 mm.

FINITURA FINISH	OLV	OGR
--------------------	-----	-----

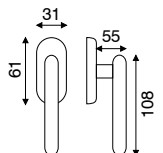



**Art. 1.8461**

Guarnitura rosetta e bocchetta ø 45 mm a pressione.  
Door handle on ø 45 mm pressured fixed rose and escutcheon.

FINITURA FINISH	OLV	OGR	CRS

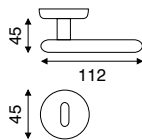

**Art. 4.8460**

DK movimento in fibra con rosetta ovale 31x61 mm.  
DK nylon mechanism on oval rose 31x61 mm.

FINITURA FINISH	OLV	OGR	CRS

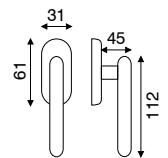

**Art. 1.9861**

Guarnitura rosetta e bocchetta ø 45 mm a pressione.  
Door handle on ø 45 mm pressured fixed rose and escutcheon.

FINITURA FINISH	OLV	CRS

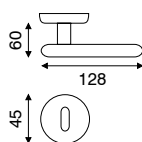

**Art. 4.9860**

DK movimento in fibra con rosetta ovale 31x61 mm.  
DK nylon mechanism on oval rose 31x61 mm.

FINITURA FINISH	OLV	CRS

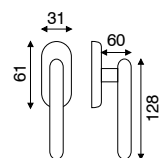



# SERIE COMETA



## Art. MA 2.2461

Guarnitura rosetta e bocchetta  $\varnothing$  45 mm a pressione.  
Door handle on  $\varnothing$  45 mm pressured fixed rose and escutcheon.

FINITURA FINISH	OLV	CRS
-----------------	-----	-----

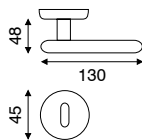

## Art. FI 2.2460

DK movimento in fibra con rosetta ovale 31x61 mm.  
DK nylon mechanism on oval rose 31x61 mm.

FINITURA FINISH	OLV	CRS
-----------------	-----	-----

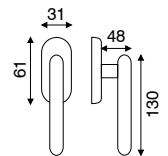

# SERIE ONDA



## Art. 1.0961

Guarnitura rosetta e bocchetta  $\varnothing$  45 mm a pressione.  
Door handle on  $\varnothing$  45 mm pressured fixed rose and escutcheon.

FINITURA FINISH	OLV	CR	CRS
-----------------	-----	----	-----

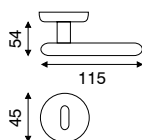

## Art. 4.0960

DK movimento in fibra con rosetta ovale 31x61 mm.  
DK nylon mechanism on oval rose 31x61 mm.

FINITURA FINISH	OLV	CR	CRS
-----------------	-----	----	-----

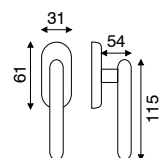



**Art. MA 2.6361**

Guarnitura rosetta e bocchetta ø 45 mm a pressione.  
Door handle on ø 45 mm pressured fixed rose and escutcheon.

FINITURA FINISH	OLV	CRS
--------------------	-----	-----

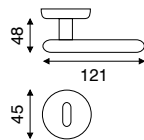

**Art. FI 2.6360**

DK movimento in fibra con rosetta ovale 31x61 mm.  
DK nylon mechanism on oval rose 31x61 mm.

FINITURA FINISH	OLV	CRS
--------------------	-----	-----

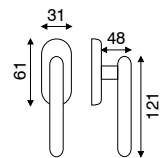

**Art. 1.0861**

Guarnitura rosetta e bocchetta ø 45 mm a pressione.  
Door handle on ø 45 mm pressured fixed rose and escutcheon.

FINITURA FINISH	OLV	CRS
--------------------	-----	-----

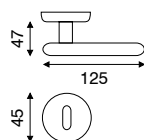

**Art. 4.0860**

DK movimento in fibra con rosetta ovale 31x61 mm.  
DK nylon mechanism on oval rose 31x61 mm.

FINITURA FINISH	OLV	CRS
--------------------	-----	-----

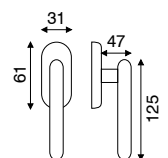

## SERIE POROS



### Art. MA 2.4761

Guarnitura rosetta e bocchetta  $\varnothing$  45 mm a pressione.

Door handle on  $\varnothing$  45 mm pressured fixed rose and escutcheon.

FINITURA FINISH	OLV	CRS

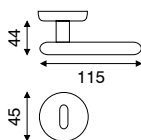

### Art. FI 2.4760

DK movimento in fibra con rosetta ovale 31x61 mm.

DK nylon mechanism on oval rose 31x61 mm.

FINITURA FINISH	OLV	CRS

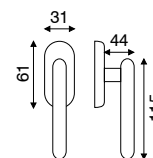

## SERIE OLARIA



### Art. 1.1261

Guarnitura rosetta e bocchetta  $\varnothing$  45 mm a pressione.

Door handle on  $\varnothing$  45 mm pressured fixed rose and escutcheon.

FINITURA FINISH	OLV	CRS

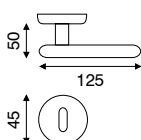

### Art. 4.1260

DK movimento in fibra con rosetta ovale 31x61 mm.

DK nylon mechanism on oval rose 31x61 mm.

FINITURA FINISH	OLV	CRS

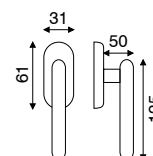



**Art. 1.9961**

Guarnitura rosetta e bocchetta ø 45 mm a pressione.  
Door handle on ø 45 mm pressured fixed rose and escutcheon.

FINITURA FINISH	OLV	CRS
--------------------	-----	-----

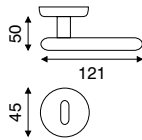

**Art. 4.9960**

DK movimento in fibra con rosetta ovale 31x61 mm.  
DK nylon mechanism on oval rose 31x61 mm.

FINITURA FINISH	OLV	CRS
--------------------	-----	-----

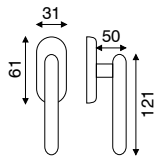

**Art. 1.3861**

Guarnitura rosetta e bocchetta ø 45 mm a pressione.  
Door handle on ø 45 mm pressured fixed rose and escutcheon.

FINITURA FINISH	OLV	CRS
--------------------	-----	-----

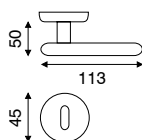

**Art. 4.3860**

DK movimento in fibra con rosetta ovale 31x61 mm.  
DK nylon mechanism on oval rose 31x61 mm.

FINITURA FINISH	OLV	CRS
--------------------	-----	-----

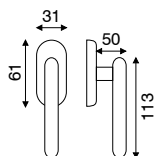



**Art. 1.5460**

Guarnitura rosetta e bocchetta ø 50 mm ad avvitare.  
Door handle on ø 50 mm screwed rose and escutcheon.

FINITURA FINISH	OLV	CRS

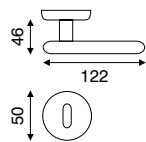

**Art. 4.5460**

DK movimento in fibra con rosetta ovale 31x61 mm.  
DK nylon mechanism on oval rose 31x61 mm.

FINITURA FINISH	OLV	CRS

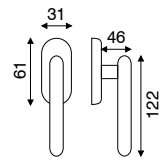

**Art. 1.4361**

Guarnitura rosetta e bocchetta ø 45 mm a pressione.  
Door handle on ø 45 mm pressured fixed rose and escutcheon.

FINITURA FINISH	OLV	OGR

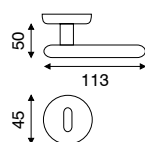

**Art. 4.4360**

DK movimento in fibra con rosetta ovale 31x61 mm.  
DK nylon mechanism on oval rose 31x61 mm.

FINITURA FINISH	OLV	OGR

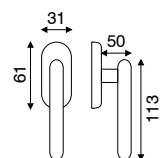

## SERIE DRÒ



### Art. 1.8761

Guarnitura rosetta e bocchetta ø 45 mm a pressione.

Door handle on ø 45 mm pressured fixed rose and escutcheon.

FINITURA FINISH	OLV	CRS

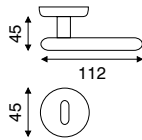

### Art. 4.8760

DK movimento in fibra con rosetta ovale 31x61 mm.

DK nylon mechanism on oval rose 31x61 mm.

FINITURA FINISH	OLV	CRS

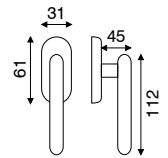

## SERIE PARO



### Art. 1.6861

Guarnitura rosetta e bocchetta ø 45 mm a pressione.

Door handle on ø 45 mm pressured fixed rose and escutcheon.

FINITURA FINISH	OLV	CRS

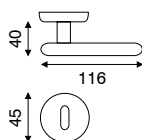

### Art. 4.6860

DK movimento in fibra con rosetta ovale 31x61 mm.

DK nylon mechanism on oval rose 31x61 mm.

FINITURA FINISH	OLV	CRS

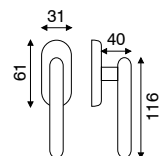



**Art. MA 2.8261**

Guarnitura rosetta e bocchetta ø 45 mm a pressione.  
Door handle on ø 45 mm pressured fixed rose and escutcheon.

FINITURA FINISH	OLV	CRS
--------------------	-----	-----

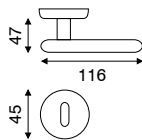

**Art. FI 2.8260**

DK movimento in fibra con rosetta ovale 31x61 mm.  
DK nylon mechanism on oval rose 31x61 mm.

FINITURA FINISH	OLV	CRS
--------------------	-----	-----

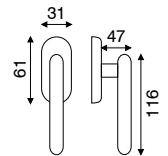

**Art. 1.2261**

Guarnitura rosetta e bocchetta ø 45 mm a pressione.  
Door handle on ø 45 mm pressured fixed rose and escutcheon.

FINITURA FINISH	OLV	OGR
--------------------	-----	-----

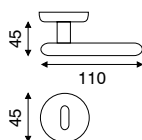

**Art. 4.2260**

DK movimento in fibra con rosetta ovale 31x61 mm.  
DK nylon mechanism on oval rose 31x61 mm.

FINITURA FINISH	OLV	OGR
--------------------	-----	-----

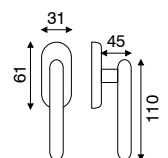



**Art. 1.4261**

Guarnitura rosetta e bocchetta ø 45 mm a pressione.  
Door handle on ø 45 mm pressured fixed rose and escutcheon.

FINITURA FINISH	OLV	OGR	CRS
--------------------	-----	-----	-----

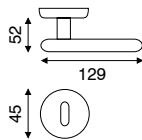

**Art. 4.4260**

DK movimento in fibra con rosetta ovale 31x61 mm.  
DK nylon mechanism on oval rose 31x61 mm.

FINITURA FINISH	OLV	OGR	CRS
--------------------	-----	-----	-----

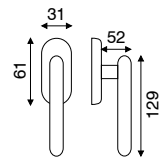

**Art. 1.4261 BIC**

Guarnitura rosetta e bocchetta ø 45 mm a pressione.  
Door handle on ø 45 mm pressured fixed rose and escutcheon.

FINITURA FINISH	OLV/SAT	CR/CRS
--------------------	---------	--------

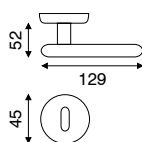

**Art. 4.4260 BIC**

DK movimento in fibra con rosetta ovale 31x61 mm.  
DK nylon mechanism on oval rose 31x61 mm.

FINITURA FINISH	OLV/SAT	CR/CRS
--------------------	---------	--------

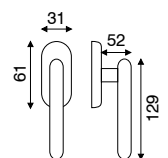





**Art. MA 2.2861**

Guarnitura rosetta e bocchetta ø 45 mm a pressione.  
Door handle on ø 45 mm pressured fixed rose and escutcheon.

FINITURA FINISH	OLV	CRS
--------------------	-----	-----

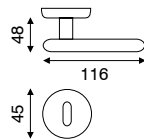

**Art. FI 2.2860**

DK movimento in fibra con rosetta ovale 31x61 mm.  
DK nylon mechanism on oval rose 31x61 mm.

FINITURA FINISH	OLV	CRS
--------------------	-----	-----

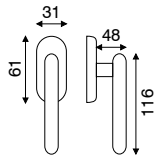

**Art. 1.8660**

Guarnitura rosetta e bocchetta ø 50 mm ad avvitare.  
Door handle on ø 50 mm screwed rose and escutcheon.

FINITURA FINISH	OLV/SAT	CR/CRS
--------------------	---------	--------

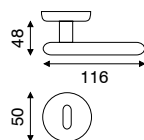

**Art. 4.8660**

DK movimento in fibra con rosetta ovale 31x61 mm.  
DK nylon mechanism on oval rose 31x61 mm.

FINITURA FINISH	OLV/SAT	CR/CRS
--------------------	---------	--------

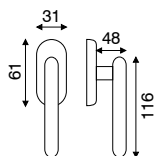

## SERIE VIERRE



### Art. 1.0561

Guarnitura rosetta e bocchetta  $\varnothing$  45 mm a pressione.  
Door handle on  $\varnothing$  45 mm pressured fixed rose and escutcheon.

FINITURA FINISH	OLV
-----------------	-----

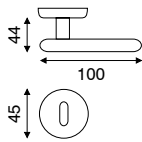

### Art. 4.0560

DK movimento in fibra con rosetta ovale 31x61 mm.  
DK nylon mechanism on oval rose 31x61 mm.

FINITURA FINISH	OLV
-----------------	-----

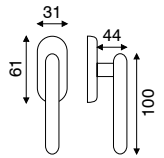

## SERIE MEDEA



### Art. 1.9761

Guarnitura rosetta e bocchetta  $\varnothing$  45 mm a pressione.  
Door handle on  $\varnothing$  45 mm pressured fixed rose and escutcheon.

FINITURA FINISH	OLV	CRS
-----------------	-----	-----

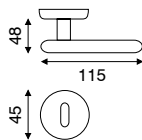

### Art. 4.9760

DK movimento in fibra con rosetta ovale 31x61 mm.  
DK nylon mechanism on oval rose 31x61 mm.

FINITURA FINISH	OLV	CRS
-----------------	-----	-----

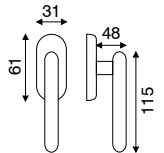

## SERIE VOGUE



### Art. 1.1461

Guarnitura rosetta e bocchetta  $\varnothing$  45 mm a pressione.  
Door handle on  $\varnothing$  45 mm pressured fixed rose and escutcheon.

FINITURA FINISH	OLV	OGR
-----------------	-----	-----

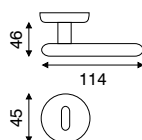

### Art. 4.1460

DK movimento in fibra con rosetta ovale 31x61 mm.  
DK nylon mechanism on oval rose 31x61 mm.

FINITURA FINISH	OLV	OGR
-----------------	-----	-----

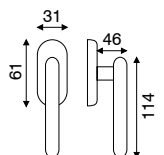

## SERIE FLÒ



### Art. 1.7960

Guarnitura rosetta e bocchetta ø 50 mm ad avvitare.

Door handle on ø 50 mm screwed rose and escutcheon.

FINITURA FINISH	OLV	CRS
--------------------	-----	-----

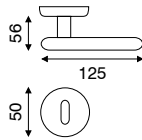

### Art. 4.7960

DK movimento in fibra con rosetta ovale 31x61 mm.

DK nylon mechanism on oval rose 31x61 mm.

FINITURA FINISH	OLV	CRS
--------------------	-----	-----

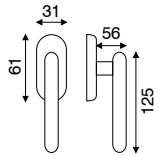

## SERIE ALCE

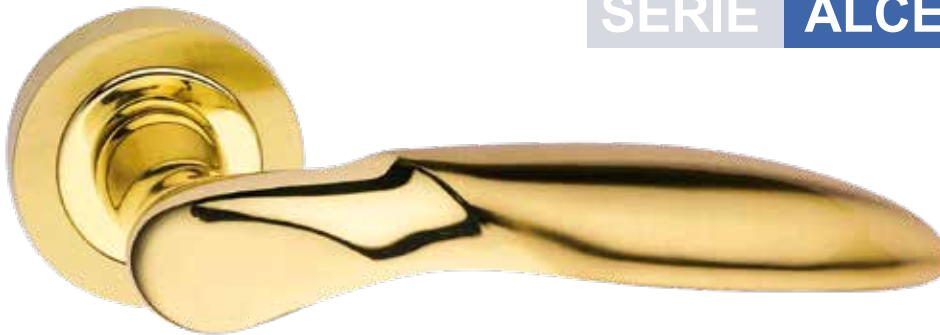

### Art. MA 2.1160

Guarnitura rosetta e bocchetta ø 50 mm ad avvitare.

Door handle on ø 50 mm screwed rose and escutcheon.

FINITURA FINISH	OLV/SAT	CR/CRS
--------------------	---------	--------

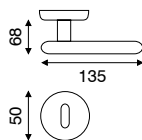

### Art. FI 2.1160

DK movimento in fibra con rosetta ovale 31x61 mm.

DK nylon mechanism on oval rose 31x61 mm.

FINITURA FINISH	OLV/SAT	CR/CRS
--------------------	---------	--------

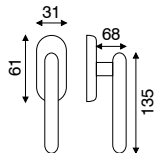

## SERIE SIRIO



### Art. 1.6960

Guarnitura rosetta e bocchetta ø 50 mm ad avvitare.

Door handle on ø 50 mm screwed rose and escutcheon.

FINITURA FINISH	OLV	CRS
--------------------	-----	-----

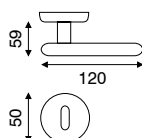

### Art. 4.6960

DK movimento in fibra con rosetta ovale 31x61 mm.

DK nylon mechanism on oval rose 31x61 mm.

FINITURA FINISH	OLV	CRS
--------------------	-----	-----

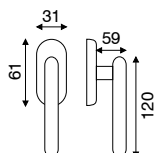



**Art. MA 2.9360**

Guarnitura rosetta e bocchetta ø 50 mm ad avvitare.  
Door handle on ø 50 mm screwed rose and escutcheon.

FINITURA FINISH	OLV/SAT	CR/CRS
--------------------	---------	--------

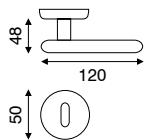

**Art. FI 2.9360**

DK movimento in fibra con rosetta ovale 31x61 mm.  
DK nylon mechanism on oval rose 31x61 mm.

FINITURA FINISH	OLV/SAT	CR/CRS
--------------------	---------	--------

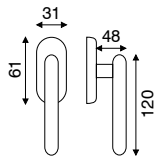

**Art. MA 2.4260**

Guarnitura rosetta e bocchetta ø 50 mm ad avvitare.  
Door handle on ø 50 mm screwed rose and escutcheon.

FINITURA FINISH	OLV/SAT	CR/CRS
--------------------	---------	--------

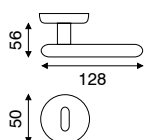

**Art. FI 2.4260**

DK movimento in fibra con rosetta ovale 31x61 mm.  
DK nylon mechanism on oval rose 31x61 mm.

FINITURA FINISH	OLV/SAT	CR/CRS
--------------------	---------	--------

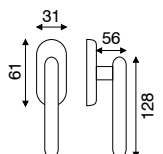

## SERIE OXA



### Art. MA 2.2061

Guarnitura rosetta e bocchetta  $\varnothing$  45 mm a pressione.  
Door handle on  $\varnothing$  45 mm pressured fixed rose and escutcheon.

FINITURA FINISH OLV/SAT CR/CRS

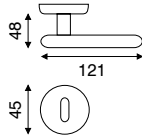

### Art. FI 2.2060

DK movimento in fibra con rosetta ovale 31x61 mm.  
DK nylon mechanism on oval rose 31x61 mm.

FINITURA FINISH OLV/SAT CR/CRS

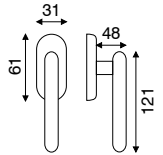

## SERIE OLIMPIA



### Art. MA 2.1772

Guarnitura rosetta e bocchetta "bombata sp"  $\varnothing$  50 mm ad avvitare.  
Door handle on  $\varnothing$  50 mm screwed "curved" rose and escutcheon.

FINITURA FINISH OLV/SAT CR/CRS

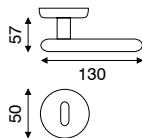

### Art. FI 2.1760

DK movimento in fibra con rosetta ovale 31x61 mm.  
DK nylon mechanism on oval rose 31x61 mm.

FINITURA FINISH OLV/SAT CR/CRS

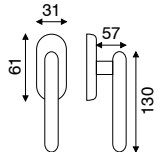

## SERIE DEA



### Art. MA 2.3560

Guarnitura rosetta e bocchetta  $\varnothing$  50 mm ad avvitare.  
Door handle on  $\varnothing$  50 mm screwed rose and escutcheon.

FINITURA FINISH CR/CRS

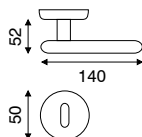

### Art. FI 2.3560

DK movimento in fibra con rosetta ovale 31x61 mm.  
DK nylon mechanism on oval rose 31x61 mm.

FINITURA FINISH CR/CRS

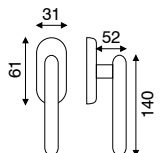

## SERIE POLARIS



### Art. MA 2.6161

Guarnitura rosetta e bocchetta  $\varnothing$  45 mm a pressione.  
Door handle on  $\varnothing$  45 mm pressured fixed rose and escutcheon.

FINITURA FINISH	OLV	CRS
--------------------	-----	-----

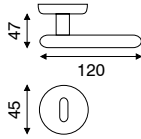

### Art. FI 2.6160

DK movimento in fibra con rosetta ovale 31x61 mm.  
DK nylon mechanism on oval rose 31x61 mm.

FINITURA FINISH	OLV	CRS
--------------------	-----	-----

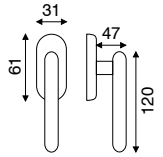

## SERIE ANIA



### Art. MA 2.4561

Guarnitura rosetta e bocchetta  $\varnothing$  45 mm a pressione.  
Door handle on  $\varnothing$  45 mm pressured fixed rose and escutcheon.

FINITURA FINISH	OLV	CRS
--------------------	-----	-----

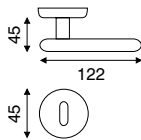

### Art. FI 2.4560

DK movimento in fibra con rosetta ovale 31x61 mm.  
DK nylon mechanism on oval rose 31x61 mm.

FINITURA FINISH	OLV	CRS
--------------------	-----	-----

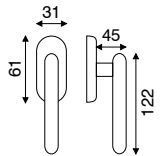

## SERIE LADY



### Art. MA 2.1661

Guarnitura rosetta e bocchetta  $\varnothing$  45 mm a pressione.  
Door handle on  $\varnothing$  45 mm pressured fixed rose and escutcheon.

FINITURA FINISH	OLV	CRS
--------------------	-----	-----

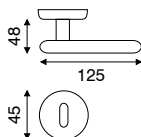

### Art. FI 2.1660

DK movimento in fibra con rosetta ovale 31x61 mm.  
DK nylon mechanism on oval rose 31x61 mm.

FINITURA FINISH	OLV	CRS
--------------------	-----	-----

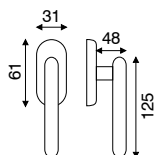

## SERIE POLARIS BIC



### Art. MA 2.6161 BIC

Guarnitura rosetta e bocchetta ø 45 mm a pressione.  
Door handle on ø 45 mm pressured fixed rose and escutcheon.

FINITURA FINISH OLV/SAT CR/CRS

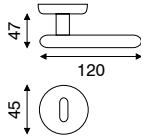

### Art. FI 2.6160 BIC

DK movimento in fibra con rosetta ovale 31x61 mm.  
DK nylon mechanism on oval rose 31x61 mm.

FINITURA FINISH OLV/SAT CR/CRS

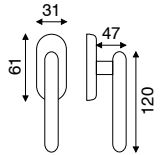

## SERIE ANIA BIC



### Art. MA 2.4561 BIC

Guarnitura rosetta e bocchetta ø 45 mm a pressione.  
Door handle on ø 45 mm pressured fixed rose and escutcheon.

FINITURA FINISH OLV/SAT CR/CRS

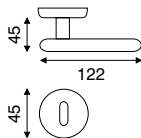

### Art. FI 2.4560 BIC

DK movimento in fibra con rosetta ovale 31x61 mm.  
DK nylon mechanism on oval rose 31x61 mm.

FINITURA FINISH OLV/SAT CR/CRS

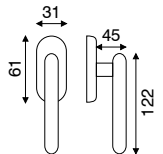

## SERIE LADY BIC



### Art. MA 2.1661 BIC

Guarnitura rosetta e bocchetta ø 45 mm a pressione.  
Door handle on ø 45 mm pressured fixed rose and escutcheon.

FINITURA FINISH OLV/SAT CR/CRS

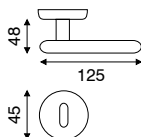

### Art. FI 2.1660 BIC

DK movimento in fibra con rosetta ovale 31x61 mm.  
DK nylon mechanism on oval rose 31x61 mm.

FINITURA FINISH OLV/SAT CR/CRS

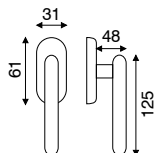

## SERIE PUNTO

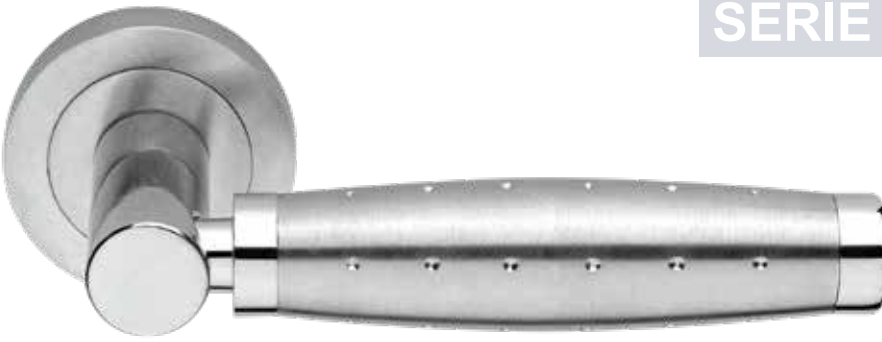

### Art. MA 2.3760

Guarnitura rosetta e bocchetta  $\varnothing$  50 mm ad avvitare.  
Door handle on  $\varnothing$  50 mm screwed rose and escutcheon.

FINITURA FINISH	CR/CRS
--------------------	--------

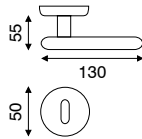

### Art. FI 2.3760

DK movimento in fibra con rosetta ovale 31x61 mm.  
DK nylon mechanism on oval rose 31x61 mm.

FINITURA FINISH	CR/CRS
--------------------	--------

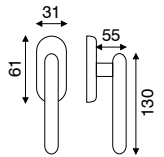

## SERIE PILAR



### Art. MA 2.2960

Guarnitura rosetta e bocchetta  $\varnothing$  50 mm ad avvitare.  
Door handle on  $\varnothing$  50 mm screwed rose and escutcheon.

FINITURA FINISH	OLV	CRS	CR/CRS
--------------------	-----	-----	--------

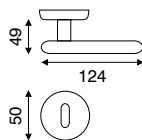

### Art. FI 2.2960

DK movimento in fibra con rosetta ovale 31x61 mm.  
DK nylon mechanism on oval rose 31x61 mm.

FINITURA FINISH	OLV	CRS	CR/CRS
--------------------	-----	-----	--------

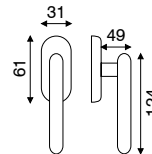

### Art. MA 2.2976

Guarnitura rosetta staccata e bocchetta quadra 45x45 mm a pressione.  
Door handle on 45x45 mm pressure unmounted rose and escutcheon.

FINITURA FINISH	CRS	CR/CRS
--------------------	-----	--------

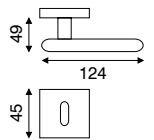

## SERIE SAMBA



### Art. MA 2.4970

Guarnitura rosetta e bocchetta "bombata"  $\varnothing$  50 mm ad avvitare.  
Door handle on  $\varnothing$  50 mm screwed "curved" rose and escutcheon.

FINITURA FINISH	OLV	CR	CRS
--------------------	-----	----	-----

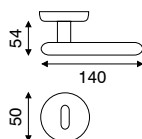

### Art. FI 2.4960

DK movimento in fibra con rosetta ovale 31x61 mm.  
DK nylon mechanism on oval rose 31x61 mm.

FINITURA FINISH	OLV	CR	CRS
--------------------	-----	----	-----

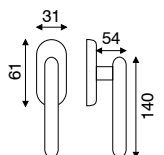



## SERIE NURI



### Art. MA 2.6470

Guarnitura rosetta e bocchetta "bombata" ø 50 mm ad avvitare.  
Door handle on ø 50 mm screwed "curved" rose and escutcheon.

FINITURA FINISH	OLV	CRS
--------------------	-----	-----

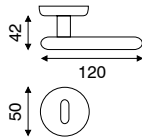

### Art. FI 2.6460

DK movimento in fibra con rosetta ovale 31x61 mm.  
DK nylon mechanism on oval rose 31x61 mm.

FINITURA FINISH	OLV	CRS
--------------------	-----	-----

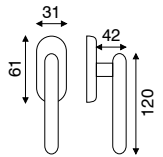

## SERIE SIERRA



### Art. MA 2.3060

Guarnitura rosetta e bocchetta ø 50 mm ad avvitare.  
Door handle on ø 50 mm screwed rose and escutcheon.

FINITURA FINISH	CRS	CR/CRS
--------------------	-----	--------

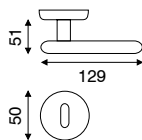

### Art. FI 2.3060

DK movimento in fibra con rosetta ovale 31x61 mm.  
DK nylon mechanism on oval rose 31x61 mm.

FINITURA FINISH	CRS	CR/CRS
--------------------	-----	--------

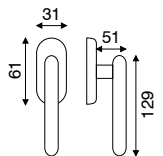

## SERIE MODÌ



### Art. MA 2.5070

Guarnitura rosetta e bocchetta "bombata" ø 50 mm ad avvitare.  
Door handle on ø 50 mm screwed "curved" rose and escutcheon.

FINITURA FINISH	OLV	CR	CRS
--------------------	-----	----	-----

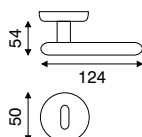

### Art. FI 2.5060

DK movimento in fibra con rosetta ovale 31x61 mm.  
DK nylon mechanism on oval rose 31x61 mm.

FINITURA FINISH	OLV	CR	CRS
--------------------	-----	----	-----

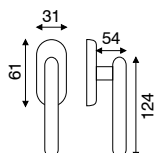

## SERIE MANU



### Art. MA 2.9868

Guarnitura rosetta e bocchetta ø 50 mm a pressione.

Door handle on ø 50 mm pressured fixed rose and escutcheon.

FINITURA FINISH	OLV	OGR	CRS
--------------------	-----	-----	-----

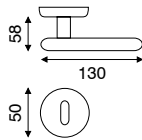

### Art. FI 2.9860

DK movimento in fibra con rosetta ovale 31x61 mm.

DK nylon mechanism on oval rose 31x61 mm.

FINITURA FINISH	OLV	OGR	CRS
--------------------	-----	-----	-----

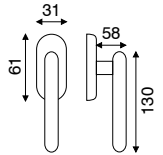

## SERIE LINEA



### Art. MA 2.2351

Guarnitura rosetta staccata e bocchetta tonda ø 45 mm a pressione.

Door handle on ø 45 mm pressured unassembled rose and escutcheon.

FINITURA FINISH	OLV	OGR	CRS
--------------------	-----	-----	-----

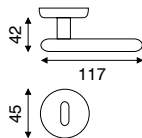

### Art. FI 2.2360

DK movimento in fibra con rosetta ovale 31x61 mm.

DK nylon mechanism on oval rose 31x61 mm.

FINITURA FINISH	OLV	OGR	CRS
--------------------	-----	-----	-----

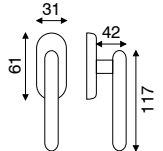

## SERIE MAXI



### Art. MA 2.7861

Guarnitura rosetta e bocchetta ø 45 mm a pressione.

Door handle on ø 45 mm pressured fixed rose and escutcheon.

FINITURA FINISH	OLV	CRS
--------------------	-----	-----

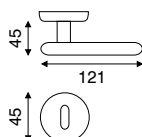

### Art. FI 2.7860

DK movimento in fibra con rosetta ovale 31x61 mm.

DK nylon mechanism on oval rose 31x61 mm.

FINITURA FINISH	OLV	CRS
--------------------	-----	-----

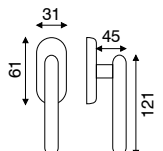

## SERIE KIM



### Art. MA 2.7661

Guarnitura rosetta e bocchetta  $\varnothing$  45 mm a pressione.

Door handle on  $\varnothing$  45 mm pressured fixed rose and escutcheon.

FINITURA FINISH	OLV	CRS
--------------------	-----	-----

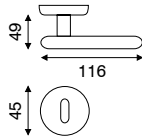

### Art. FI 2.7660

DK movimento in fibra con rosetta ovale 31x61 mm.

DK nylon mechanism on oval rose 31x61 mm.

FINITURA FINISH	OLV	CRS
--------------------	-----	-----

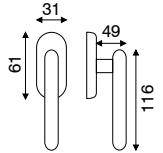

## SERIE KIM BIC



### Art. MA 2.7661 BIC

Guarnitura rosetta e bocchetta  $\varnothing$  45 mm a pressione.

Door handle on  $\varnothing$  45 mm pressured fixed rose and escutcheon.

FINITURA FINISH	OLV/SAT	CR/CRS
--------------------	---------	--------

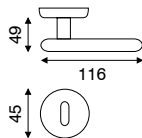

### Art. FI 2.7660 BIC

DK movimento in fibra con rosetta ovale 31x61 mm.

DK nylon mechanism on oval rose 31x61 mm.

FINITURA FINISH	OLV/SAT	CR/CRS
--------------------	---------	--------

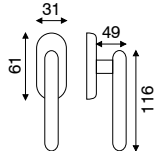

## SERIE PRAGA



### Art. 1.2661

Guarnitura rosetta e bocchetta  $\varnothing$  45 mm a pressione.

Door handle on  $\varnothing$  45 mm pressured fixed rose and escutcheon.

FINITURA FINISH	OLV	OGR	CRS
--------------------	-----	-----	-----

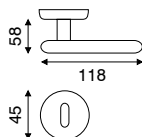

### Art. 4.2660

DK movimento in fibra con rosetta ovale 31x61 mm.

DK nylon mechanism on oval rose 31x61 mm.

FINITURA FINISH	OLV	OGR	CRS
--------------------	-----	-----	-----

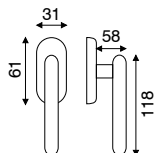

## SERIE ELLY

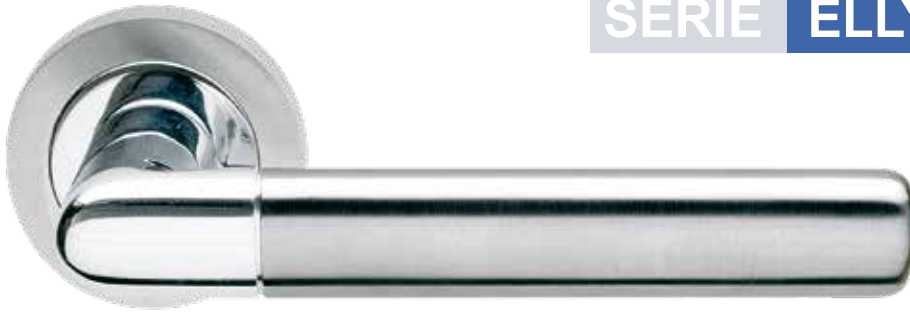

### Art. MA 2.2760

Guarnitura rosetta e bocchetta ø 50 mm ad avvitare.

Door handle on ø 50 mm screwed rose and escutcheon.

FINITURA FINISH OLV/SAT CR/CRS

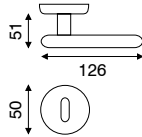

### Art. FI 2.2760

DK movimento in fibra con rosetta ovale 31x61 mm.

DK nylon mechanism on oval rose 31x61 mm.

FINITURA FINISH OLV/SAT CR/CRS

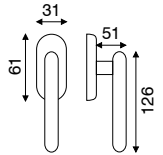

## SERIE TANGA



### Art. MA 2.3860

Guarnitura rosetta e bocchetta ø 50 mm ad avvitare.

Door handle on ø 50 mm screwed rose and escutcheon.

FINITURA FINISH OLV/SAT CR/CRS

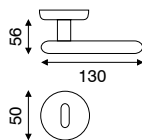

### Art. FI 2.3860

DK movimento in fibra con rosetta ovale 31x61 mm.

DK nylon mechanism on oval rose 31x61 mm.

FINITURA FINISH OLV/SAT CR/CRS

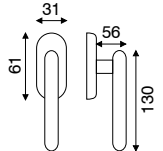

## SERIE SABINA

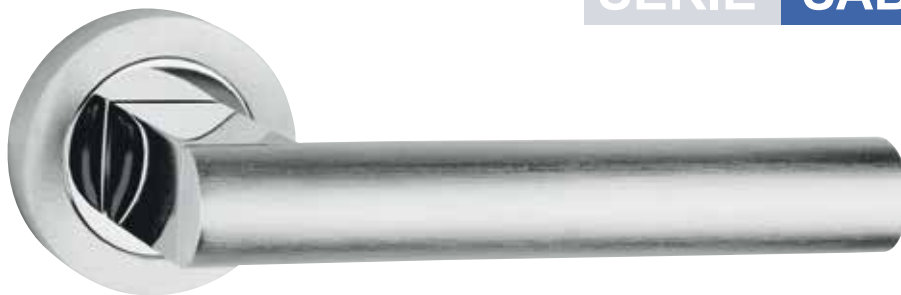

### Art. MA 2.6860

Guarnitura rosetta e bocchetta ø 50 mm ad avvitare.

Door handle on ø 50 mm screwed rose and escutcheon.

FINITURA FINISH CR/CRS

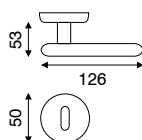

### Art. FI 2.6860

DK movimento in fibra con rosetta ovale 31x61 mm.

DK nylon mechanism on oval rose 31x61 mm.

FINITURA FINISH CR/CRS

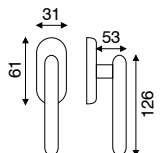

## SERIE DIAMOND



### Art. MA. 2.8174

Guarnitura rosetta staccata e bocchetta quadra 50x50 mm a pressione.  
Door handle on 50x50 mm pressured unassembled rose and escutcheon.

FINITURA FINISH	CR
-----------------	----

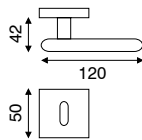

### Art. FI 2.8170

DK movimento in fibra con rosetta rettangolare 31x61 mm.  
DK nylon mechanism on rectangular rose 31x61 mm.

FINITURA FINISH	CR
-----------------	----

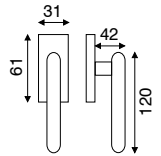

## SERIE GENOVA



### Art. MA 2.8674

Guarnitura rosetta staccata e bocchetta quadra 50x50 mm a pressione.  
Door handle on 50x50 mm pressured unassembled rose and escutcheon.

FINITURA FINISH	CR/CRS	CR	CRS
-----------------	--------	----	-----

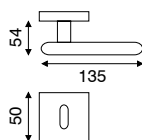

### Art. FI 2.8670

DK movimento in fibra con rosetta rettangolare 31x61 mm.  
DK nylon mechanism on rectangular rose 31x61 mm.

FINITURA FINISH	CR/CRS	CR	CRS
-----------------	--------	----	-----

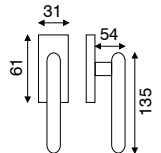

## SERIE PAULA



### Art. MA 2.6074

Guarnitura rosetta staccata e bocchetta quadra 50x50 mm a pressione.  
Door handle on 50x50 mm pressured unassembled rose and escutcheon.

FINITURA FINISH	CR/CRS	CR	CRS
-----------------	--------	----	-----

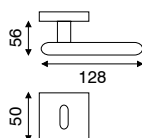

### Art. FI 2.6070

DK movimento in fibra con rosetta rettangolare 31x61 mm.  
DK nylon mechanism on rectangular rose 31x61 mm.

FINITURA FINISH	CR/CRS	CR	CRS
-----------------	--------	----	-----

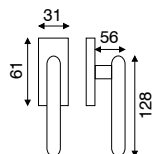

## SERIE KUBIK



### Art. MA. 2.6974

Guarnitura rosetta staccata e bocchetta quadra 50x50 mm a pressione.  
Door handle on 50x50 mm pressured unassembled rose and escutcheon.

FINITURA FINISH	CR/CRS	CR	CRS
--------------------	--------	----	-----

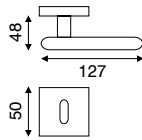

### Art. FI 2.6970

DK movimento in fibra con rosetta rettangolare 31x61 mm.  
DK nylon mechanism on rectangular rose 31x61 mm.

FINITURA FINISH	CR/CRS	CR	CRS
--------------------	--------	----	-----

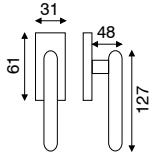

## SERIE LOTUS



### Art. MA 2.2574

Guarnitura rosetta staccata e bocchetta quadra 50x50 mm a pressione.  
Door handle on 50x50 mm pressured unassembled rose and escutcheon.

FINITURA FINISH	CR/CRS	CR	CRS
--------------------	--------	----	-----

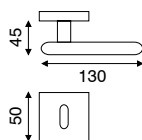

### Art. FI 2.2570

DK movimento in fibra con rosetta rettangolare 31x61 mm.  
DK nylon mechanism on rectangular rose 31x61 mm.

FINITURA FINISH	CR/CRS	CR	CRS
--------------------	--------	----	-----

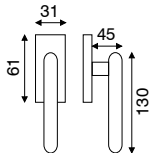

## SERIE LAURA

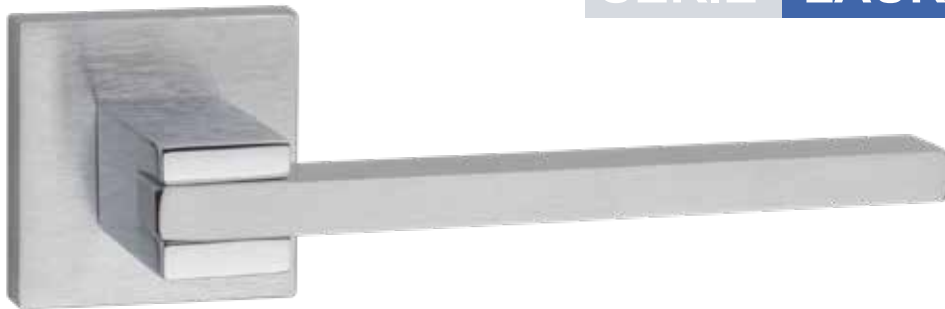

### Art. MA 2.4174

Guarnitura rosetta staccata e bocchetta quadra 50x50 mm a pressione.  
Door handle on 50x50 mm pressured unassembled rose and escutcheon.

FINITURA FINISH	CR/CRS
--------------------	--------

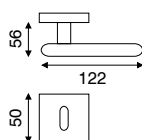

### Art. FI 2.4170

DK movimento in fibra con rosetta rettangolare 31x61 mm.  
DK nylon mechanism on rectangular rose 31x61 mm.

FINITURA FINISH	CR/CRS
--------------------	--------

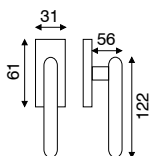

## SERIE NATALIA



### Art. MA 2.5174

Guarnitura rosetta staccata e bocchetta quadra 50x50 mm a pressione.

Door handle on 50x50 mm pressured unassembled rose and escutcheon.

FINITURA FINISH	CR/CRS	CR	CRS
--------------------	--------	----	-----

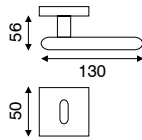

### Art. FI 2.5170

DK movimento in fibra con rosetta rettangolare 31x61 mm.

DK nylon mechanism on rectangular rose 31x61 mm.

FINITURA FINISH	CR/CRS	CR	CRS
--------------------	--------	----	-----

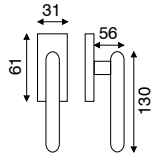

## SERIE IBER



### Art. MA 2.3174

Guarnitura rosetta staccata e bocchetta quadra 50x50 mm a pressione.

Door handle on 50x50 mm pressured unassembled rose and escutcheon.

FINITURA FINISH	CR/CRS	CR	CRS
--------------------	--------	----	-----

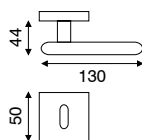

### Art. FI 2.3170

DK movimento in fibra con rosetta rettangolare 31x61 mm.

DK nylon mechanism on rectangular rose 31x61 mm.

FINITURA FINISH	CR/CRS	CR	CRS
--------------------	--------	----	-----

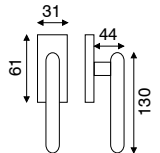

## SERIE ZOE



### Art. MA 2.6274

Guarnitura rosetta staccata e bocchetta quadra 50x50 mm a pressione.

Door handle on 50x50 mm pressured unassembled rose and escutcheon.

FINITURA FINISH	CR/CRS
--------------------	--------

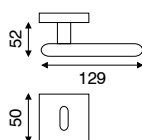

### Art. FI 2.6270

DK movimento in fibra con rosetta rettangolare 31x61 mm.

DK nylon mechanism on rectangular rose 31x61 mm.

FINITURA FINISH	CR/CRS
--------------------	--------

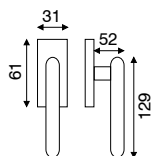







# Ottolupat

LINEA

***FERRO***

## SERIE BASKET



### Art. 1.8564

Guarnitura rosetta e bocchetta ø 50 mm viti a vista s/molla.  
Door handle on ø 50 mm rose and escutcheon w/out spring.

FINITURA FINISH FERRO NR

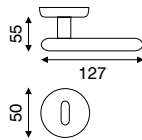

### Art. 1.8510

Guarnitura con placca Ferro.  
Door handle on plate Ferro.

FINITURA FINISH FERRO NR

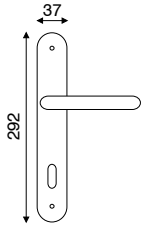

## SERIE KORA



### Art. 1.8864

Guarnitura rosetta e bocchetta ø 50 mm viti a vista s/molla.  
Door handle on ø 50 mm rose and escutcheon w/out spring.

FINITURA FINISH FERRO NR

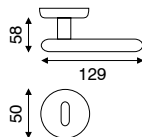

### Art. 1.8810

Guarnitura con placca Ferro.  
Door handle on plate Ferro.

FINITURA FINISH FERRO NR

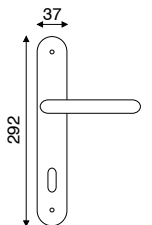

## SERIE BLACK LINE



### Art. 1.8064

Guarnitura rosetta e bocchetta ø 50 mm viti a vista s/molla.  
Door handle on ø 50 mm rose and escutcheon w/out spring.

FINITURA FINISH FERRO NR

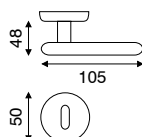

### Art. 1.8010

Guarnitura con placca Ferro.  
Door handle on plate Ferro.

FINITURA FINISH FERRO NR

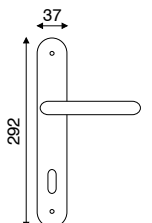



**Art. 3.2110**

Pomolo ottagonale ø 65 mm.  
Octagonal knob ø 65 mm.

FINITURA IMBALLO	FERRO NR 2
---------------------	---------------

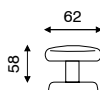

**Art. 3.2120**

Pomolo Denz ø 65 mm.  
Knob Denz ø 65 mm.

FINITURA IMBALLO	FERRO NR 2
---------------------	---------------



**Art. 7.4240**

Battente Basket ø 117 mm con perno passante.  
Door knocker Basket ø 117 mm with through screw.

FINITURA IMBALLO	FERRO NR 2
---------------------	---------------

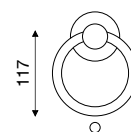

**Art. 7.4250**

Battente Kora ø 113 mm con perno passante.  
Door knocker Kora ø 113 mm with through screw.

FINITURA IMBALLO	FERRO NR 2
---------------------	---------------

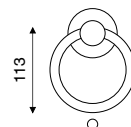

**Art. 7.4230**

Battente Denz ø 117 mm con perno passante.  
Door knocker Denz ø 117 mm with through screw.

FINITURA IMBALLO	FERRO NR 2
---------------------	---------------

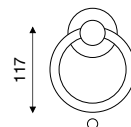





# Ottoballi

LINEA

*PLASTICA*

## SERIE MARE

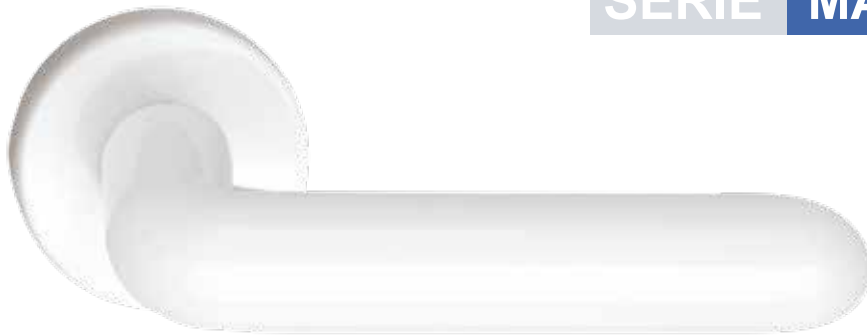

### Art. 1.0460

Guarnitura rosetta e bocchetta  $\varnothing$  50 mm a pressione.

Door handle on  $\varnothing$  50 mm pressured fixed rose and escutcheon.

FINITURA FINISH	BN	NR
--------------------	----	----

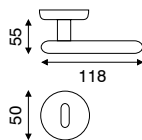

### Art. 4.0460

DK movimento in fibra con rosetta ovale 31x61 mm.

DK nylon mechanism on oval rose 31x61 mm.

FINITURA FINISH	BN	NR
--------------------	----	----

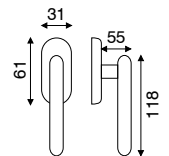

## SERIE MOON

### Art. 1.0470

Guarnitura rosetta e bocchetta  $\varnothing$  50 mm a pressione.

Door handle on  $\varnothing$  50 mm pressured fixed rose and escutcheon.

FINITURA FINISH	BN	NR
--------------------	----	----

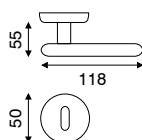

### Art. 4.0470

DK movimento in fibra con rosetta ovale 31x61 mm.

DK nylon mechanism on oval rose 31x61 mm.

FINITURA FINISH	BN	NR
--------------------	----	----

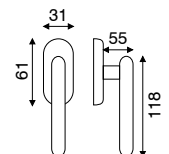

### Art. 4.0410

Cremonese o martellina.  
Window handle.

FINITURA IMBALLO	BN 10	NR 10
---------------------	----------	----------

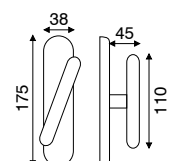



**Art. 3.2100**

Pomolo fisso ø 75 mm perno passante.  
Fixed knob ø 75 mm with through screw.

FINITURA IMBALLO	BN 12	NR 12
---------------------	----------	----------



**Art. 3.2470**

Portabito tondo.  
Round coat-hook.

FINITURA IMBALLO	BN 12	NR 12
---------------------	----------	----------



**Art. 3.2475**

Portabito Arco.  
Arco coat-hook.

FINITURA IMBALLO	BN 12	NR 12
---------------------	----------	----------



**Art. 3.2866**

Coppia nottolino wc Q6 con visualizzatore l/o su rosetta ø 50 mm a pressione.  
Wc set with display free/busy on ø 50 mm pressure fixed rose.

FINITURA IMBALLO	BN 10	NR 10
---------------------	----------	----------







ottali

LINEA

*PORCELLANA*



## SERIE SONIA / MAYA

PORCELLANA BIANCA



### Art. 1.4510

Guarnitura con placca "10".  
Door handle on plate "10".

FINITURA FINISH	OLV	OGR	ANT BL
--------------------	-----	-----	--------

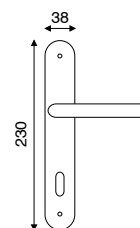

### Art. 1.4561

Guarnitura rosetta e bocchetta  $\varnothing$  45 mm a pressione.  
Door handle on  $\varnothing$  45 mm pressured fixed rose and escutcheon.

FINITURA FINISH	OLV	OGR	ANT BL
--------------------	-----	-----	--------

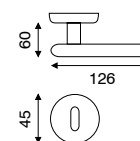

### Art. 1.4565

Guarnitura rosetta e bocchetta "Lux"  $\varnothing$  45 mm ad avvitare.  
Door handle on  $\varnothing$  45 mm screwed rose and escutcheon.

FINITURA FINISH	OLV	OGR	ANT BL
--------------------	-----	-----	--------

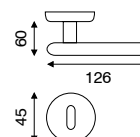

### Art. 4.4510

Cremonese o martellina.  
Window handle.

FINITURA FINISH	OLV	OGR	ANT BL
--------------------	-----	-----	--------

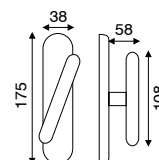

### Art. 4.4560

DK movimento in fibra con rosetta ovale 31x61 mm.  
DK nylon mechanism on oval rose 31x61 mm.

FINITURA FINISH	OLV	OGR	ANT BL
--------------------	-----	-----	--------

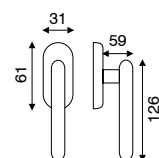



## SERIE LARA / GAYA

PORCELLANA CHAMPAGNE



### Art. 1.6110

Guarnitura con placca "10".  
Door handle on plate "10".

FINITURA FINISH	OLV	OGR	ANT BL

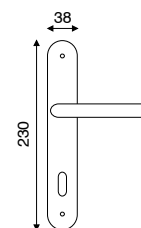

### Art. 1.6161

Guarnitura rosetta e bocchetta  $\varnothing$  45 mm a pressione.  
Door handle on  $\varnothing$  45 mm pressured fixed rose and escutcheon.

FINITURA FINISH	OLV	OGR	ANT BL

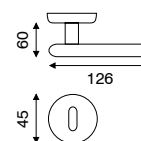

### Art. 1.6165

Guarnitura rosetta e bocchetta "Lux"  $\varnothing$  45 mm ad avvitare.  
Door handle on  $\varnothing$  45 mm screwed rose and escutcheon.

FINITURA FINISH	OLV	OGR	ANT BL

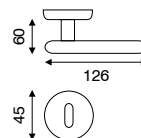

### Art. 4.6110

Cremonese o martellina.  
Window handle.

FINITURA FINISH	OLV	OGR	ANT BL

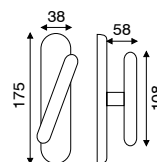

### Art. 4.6160

DK movimento in fibra con rosetta ovale 31x61 mm.  
DK nylon mechanism on oval rose 31x61 mm.

FINITURA FINISH	OLV	OGR	ANT BL

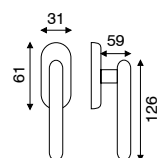

# SERIE RAYA

PORCELLANA CHAMPAGNE CRACKLÈ



## Art. 1.7761

Guarnitura rosetta e bocchetta  $\varnothing$  45 mm a pressione.

Door handle on  $\varnothing$  45 mm pressured fixed rose and escutcheon.

FINITURA FINISH	OLV	OGR	ANT BL

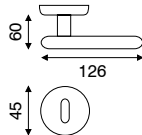

## Art. 4.7760

DK movimento in fibra con rosetta ovale 31x61 mm.

DK nylon mechanism on oval rose 31x61 mm.

FINITURA FINISH	OLV	OGR	ANT BL

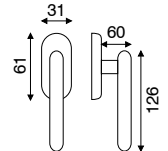

# SERIE SONIA BLU

PORCELLANA BIANCA CON FIORE BLU



## Art. 1.5561

Guarnitura rosetta e bocchetta  $\varnothing$  45 mm a pressione.

Door handle on  $\varnothing$  45 mm pressured fixed rose and escutcheon.

FINITURA FINISH	OLV	OGR	ANT BL

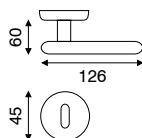

## Art. 4.5510

Cremonese o martellina.  
Window handle.

FINITURA FINISH	OLV	OGR	ANT BL

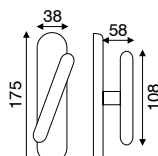

## Art. 4.5560

DK movimento in fibra con rosetta ovale 31x61 mm.

DK nylon mechanism on oval rose 31x61 mm.

FINITURA FINISH	OLV	OGR	ANT BL

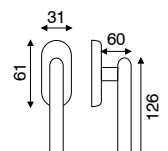

# SERIE ANNA

PORCELLANA BIANCA DECORATA



## Art. 1.6261

Guarnitura rosetta e bocchetta ø 45 mm a pressione.  
Door handle on ø 45 mm pressured fixed rose and escutcheon.

FINITURA FINISH	OLV	OGR	ANT BL

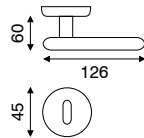

## Art. 4.6210

Cremonese o martellina.  
Window handle.

FINITURA FINISH	OLV	OGR	ANT BL

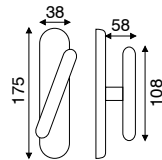

## Art. 4.6260

DK movimento in fibra con rosetta ovale 31x61 mm.  
DK nylon mechanism on oval rose 31x61 mm.

FINITURA FINISH	OLV	OGR	ANT BL

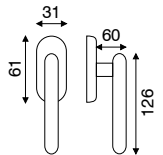

# SERIE GEMMA

PORCELLANA CHAMPAGNE DECORATA



## Art. 1.6061

Guarnitura rosetta e bocchetta ø 45 mm a pressione.  
Door handle on ø 45 mm pressured fixed rose and escutcheon.

FINITURA FINISH	OLV	OGR	ANT BL

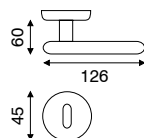

## Art. 4.6010

Cremonese o martellina.  
Window handle.

FINITURA FINISH	OLV	OGR	ANT BL

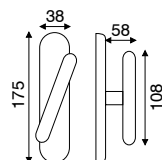

## Art. 4.6060

DK movimento in fibra con rosetta ovale 31x61 mm.  
DK nylon mechanism on oval rose 31x61 mm.

FINITURA FINISH	OLV	OGR	ANT BL

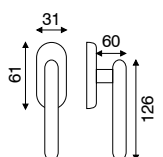

A close-up photograph of a violin and its bow. The violin's body is a rich, dark reddish-brown wood, and the f-hole is visible. The bow is made of light-colored wood with dark hair. A white semi-transparent banner is overlaid across the middle of the image, containing the word "Cott" in a large, white, sans-serif font.

Cott

LINEA

caali

# *SICUREZZA*

SERIE  
HOTEL

SERIE  
TAGLIAFUOCO

SERIE  
KIT BLINDO

SERIE ACCESSORI  
PER PORTE BLINDATE

SERIE DEFENDER

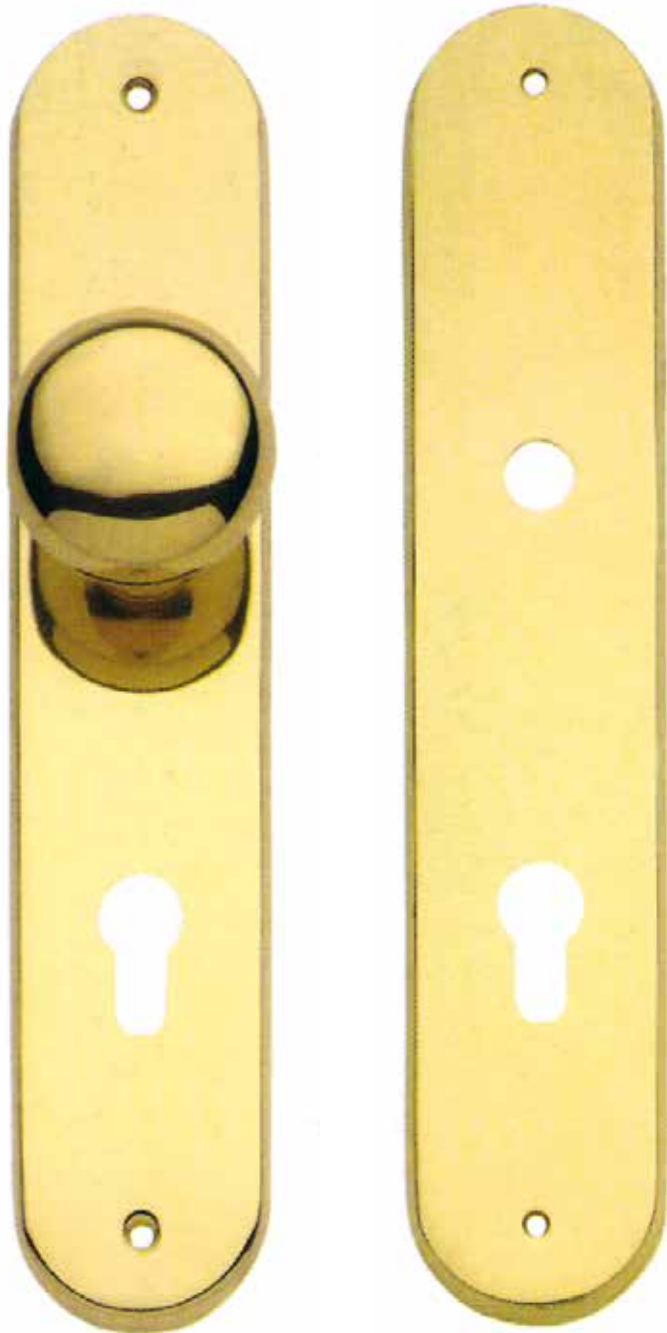

**Art. CHV 1.01801**

GRT ingresso universale con placca "10" - 230 x 38 mm con pomolo Victorian fisso.

DH universal entrance on plate "10" - 230 x 38 mm with fixed Victorian knob.

FINITURA FINISH	OLV	OGR	CR	CRS

**Art. CHV 3.01801**

GRT ingresso universale con placca "30" - 278 x 56 mm con pomolo Victorian fisso.

DH universal entrance on plate "30" - 278 x 56 mm with fixed Victorian knob.

FINITURA FINISH	OLV	OGR	CR	CRS

**AL COSTO INDICATO BISOGNA AGGIUNGERE IL PREZZO DELLA MANIGLIA SELEZIONATA,  
CHE SARÀ COMUNICATO IN FASE DI CONFERMA D'ORDINE.  
N.B. : SPECIFICARE SEMPRE IL VERSO DI APERTURA DELLA MANIGLIA (VEDI PAGINA 307)**





**CERTIFICATO  
DIN 18 273 FS**

**Art. MA 2.9210**

Maniglia per porta tagliafuoco Q9 yale 72 mm.  
Fire stop door handle.

FINITURA FINISH	NERO
--------------------	------

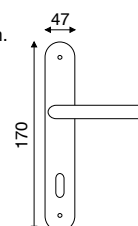

# SERIE KIT BLINDO

## KB 28076

Set per blindati composto da:  
 1/2 ELLE R.50x50 mm molla incorporata  
 POMOLO DAVID Art. 3.2025  
 LIMITATORE Art. 6.0877  
 SPIONCINO Art. 9.0531.06  
 Fissaggio A oppure B

Set for armoured door:  
 1/2 ELLE 50x50 mm with spring  
 DAVID KNOB Art. 3.2025  
 SAFETY KNOB Art. 6.0877  
 OPTICAL VIEWER Art. 9.0531.07  
 Fixing system A or B

FINITURA  
IMBALLO

CRS  
1

CR  
1



Cod. 9.0202 FERRO ESPANSIONE



Cod. 9.0204 FERRO NYPLES



## LINEA QUADRA

## KB 21968

Set per blindati composto da:  
 1/2 OMEGA R.50 mm senza molla  
 POMOLO OMEGA Art. 3.6450  
 LIMITATORE Art. 6.0156 A  
 SPIONCINO Art. 9.0531 A  
 Fissaggio A oppure B

Set for armoured door:  
 1/2 OMEGA R.50 mm without spring  
 OMEGA KNOB Art. 3.2030  
 SAFETY KNOB Art. 6.0156 A  
 OPTICAL VIEWER Art. 9.0531 A  
 Fixing system A or B

FINITURA  
IMBALLO

ALL.BR  
1

ALL.ARG  
1



Cod. 9.0202 FERRO ESPANSIONE



Cod. 9.0204 FERRO NYPLES



## LINEA ECO

## KB 1956 ES/NY

Set per blindati composto da:  
 1/2 KAROL R.50 mm senza molla  
 POMOLO ARES Art. 3.2030  
 LIMITATORE Art. 6.0156  
 SPIONCINO Art. 9.0531  
 Fissaggio A oppure B

Set for armoured door:  
 1/2 KAROL R.50 mm without spring  
 ARES KNOB Art. 3.2030  
 SAFETY KNOB Art. 6.0156  
 OPTICAL VIEWER Art. 9.0531  
 Fixing system A or B

FINITURA IMBALLO	OLV 1	OGR 1	CRS 1
---------------------	----------	----------	----------



Cod. 9.0202 FERRO ESPANSIONE



Cod. 9.0204 FERRO NYPLES



## LINEA OTTONE

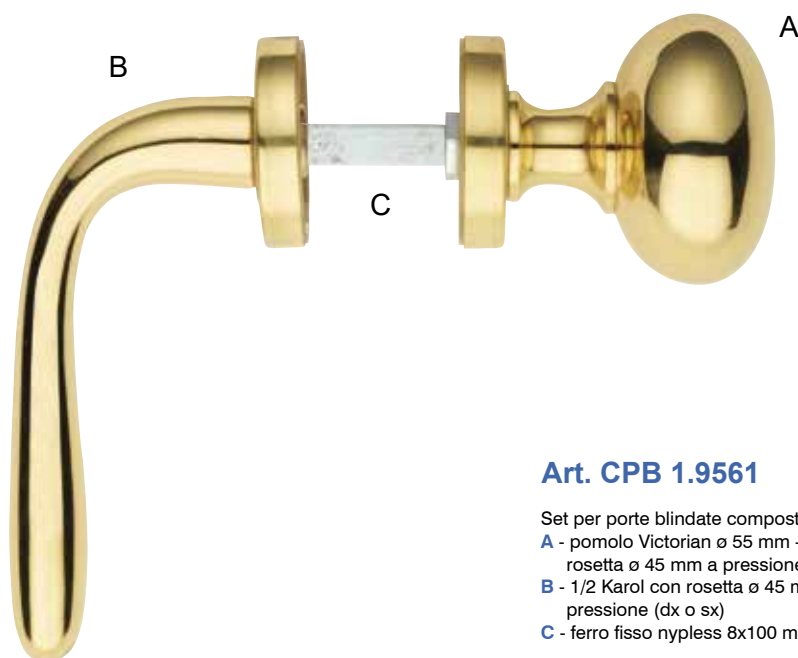

### Art. CPB 1.9561

Set per porte blindate composto da:  
**A** - pomolo Victorian ø 55 mm - con rosetta ø 45 mm a pressione  
**B** - 1/2 Karol con rosetta ø 45 mm a pressione (dx o sx)  
**C** - ferro fisso nypless 8x100 mm

Set for armoured door consisting in:  
**A** - knob Victorian ø 55 mm pressured fixed rose ø 45 mm for knob  
**B** - 1/2 Karol handle pressured fixed rose ø 45 mm for knob  
**C** - nypless fixed spindle 8x100 mm

FINITURA IMBALLO	OLV 1	OGR 1	CRS 1
---------------------	----------	----------	----------

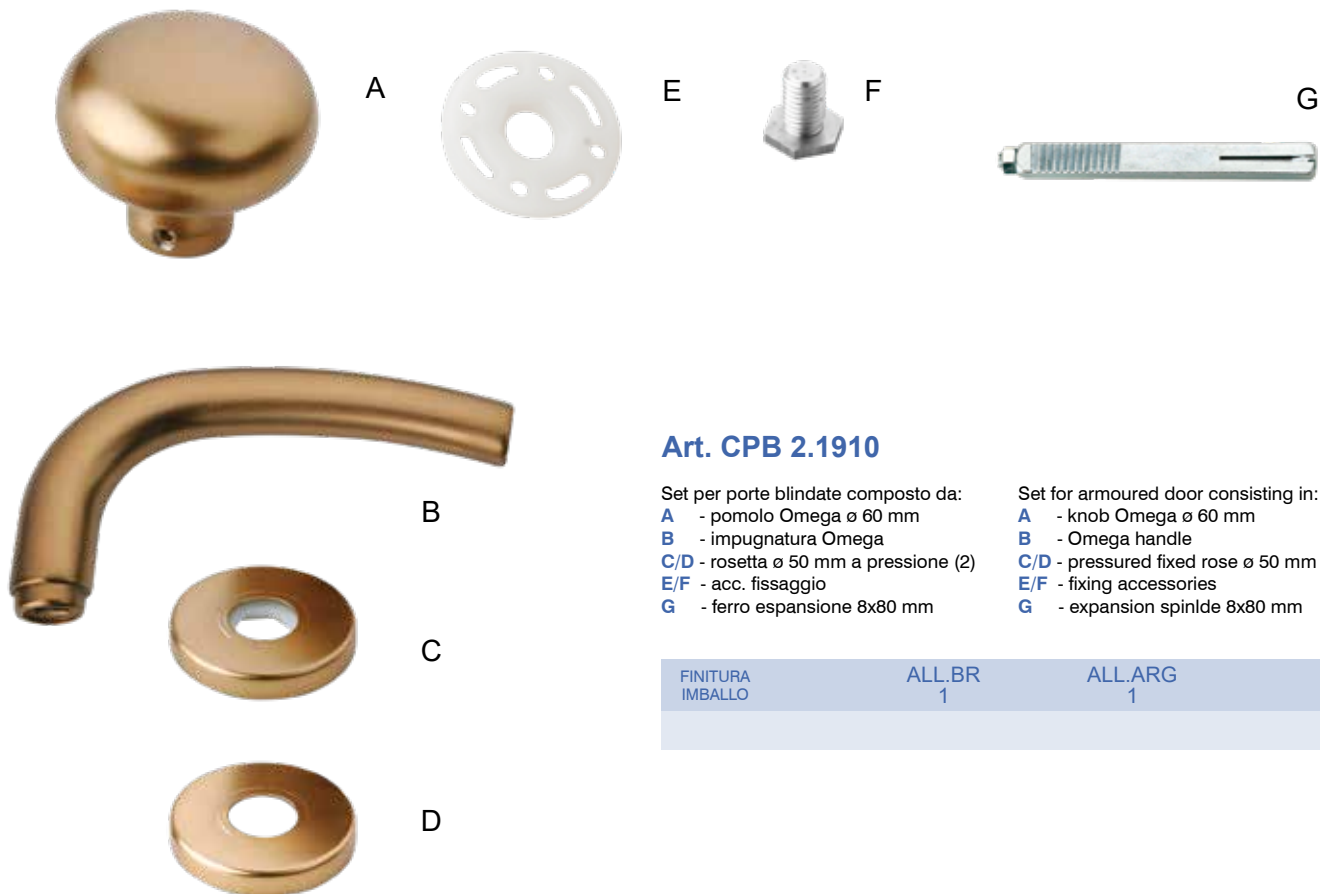

### Art. CPB 2.1910

Set per porte blindate composto da:

- A - pomolo Omega ø 60 mm
- B - impugnatura Omega
- C/D - rosetta ø 50 mm a pressione (2)
- E/F - acc. fissaggio
- G - ferro espansione 8x80 mm

Set for armoured door consisting in:

- A - knob Omega ø 60 mm
- B - Omega handle
- C/D - pressured fixed rose ø 50 mm (2)
- E/F - fixing accessories
- G - expansion spinlde 8x80 mm

FINITURA IMBALLO	ALL.BR 1	ALL.ARG 1
---------------------	-------------	--------------



### Art. CPB 1.6470

Set per porte blindate composto da:

- A - pomolo Omega ø 60 mm
- B - impugnatura Thea
- C/D - rosetta ø 50 mm a pressione (2)
- E/F - acc. fissaggio
- G - ferro espansione 8x80 mm

Set for armoured door consisting in:

- A - knob Omega ø 60 mm
- B - Thea handle
- C/D - pressured fixed rose ø 50 mm (2)
- E/F - fixing accessories
- G - expansion spinlde 8x80 mm

FINITURA IMBALLO	ALL.BR 1	ALL.ARG 1
---------------------	-------------	--------------

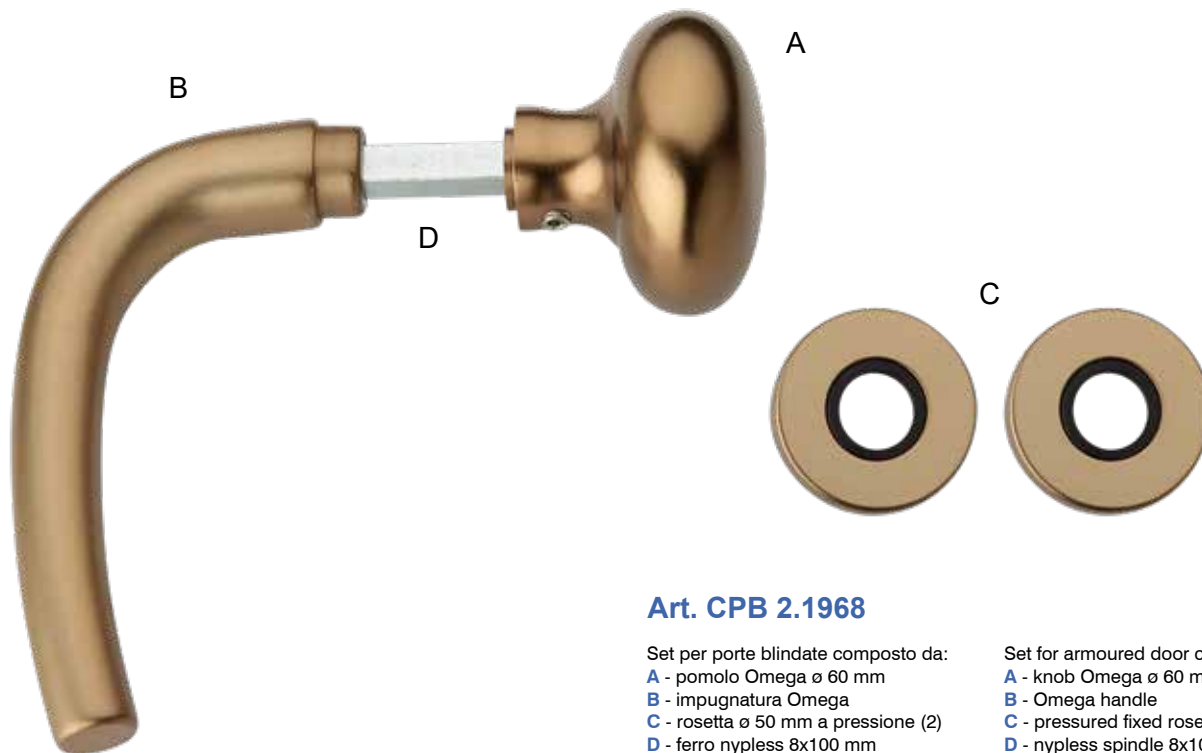

### Art. CPB 2.1968

Set per porte blindate composto da:

- A - pomolo Omega ø 60 mm
- B - impugnatura Omega
- C - rosetta ø 50 mm a pressione (2)
- D - ferro nypless 8x100 mm

Set for armoured door consisting in:

- A - knob Omega ø 60 mm
- B - Omega handle
- C - pressured fixed rose ø 50 mm (2)
- D - nypless spindle 8x100 mm

FINITURA  
IMBALLO

ALL.BR  
6

ALL.ARG  
6

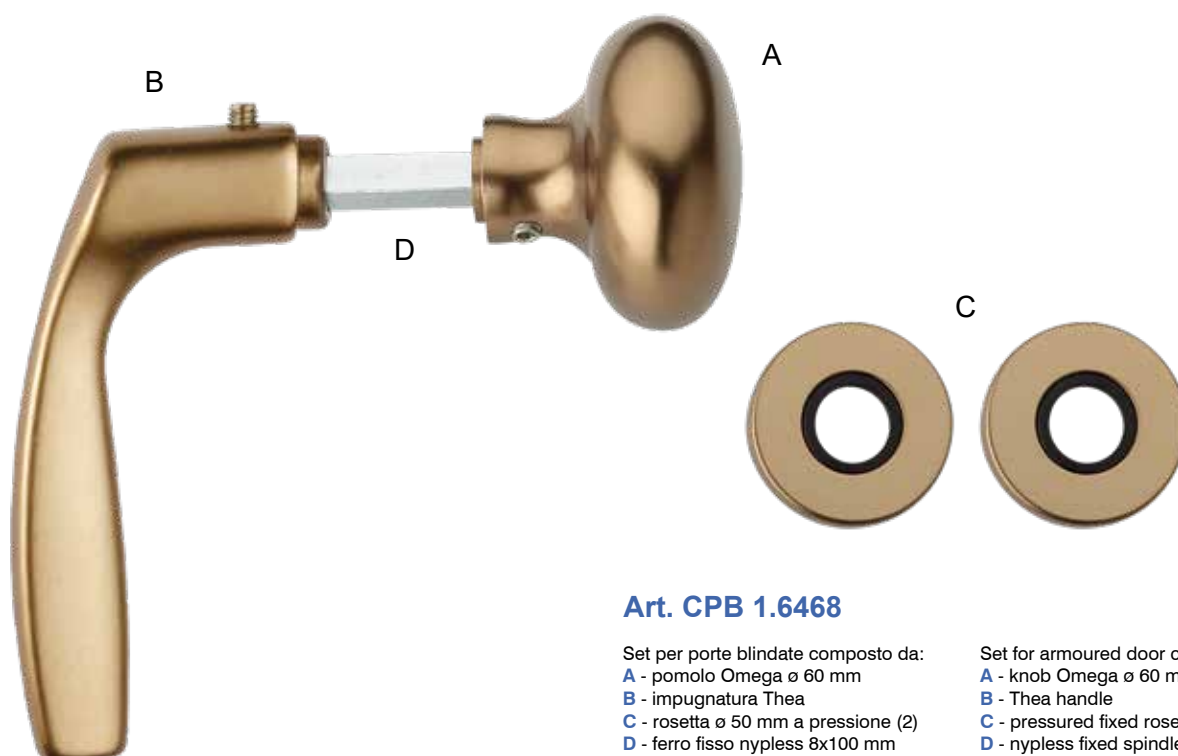

### Art. CPB 1.6468

Set per porte blindate composto da:

- A - pomolo Omega ø 60 mm
- B - impugnatura Thea
- C - rosetta ø 50 mm a pressione (2)
- D - ferro fisso nypless 8x100 mm

Set for armoured door consisting in:

- A - knob Omega ø 60 mm
- B - Thea handle
- C - pressured fixed rose ø 50 mm (2)
- D - nypless fixed spindle 8x100 mm

FINITURA  
IMBALLO

ALL.BR  
6

ALL.ARG  
6

POMOLI CILINDRO

**Art. 6.0135**

Pomello per cilindro foro 8 mm.  
Cylinder knob 8 mm.

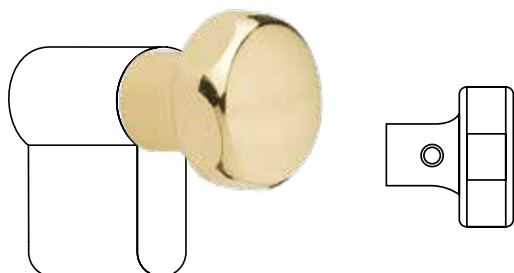

	ø 30 mm	ø 35 mm	ø 40 mm
FINITURA IMBALLO	OLV 10	OLV 10	OLV 10
FINITURA IMBALLO	OGR 10	OGR 10	OGR 10
FINITURA IMBALLO	CRS 10	CRS 10	CRS 10

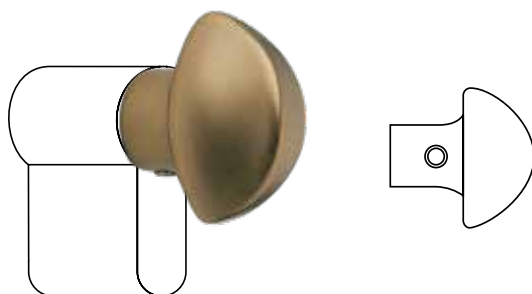

**Art. 6.0149**

Pomello per cilindro foro 8 mm.  
Cylinder knob 8 mm.

	OLV 10	OGR 10	CRS 10	ALL.BR 10	ALL.ARG 10
FINITURA IMBALLO					

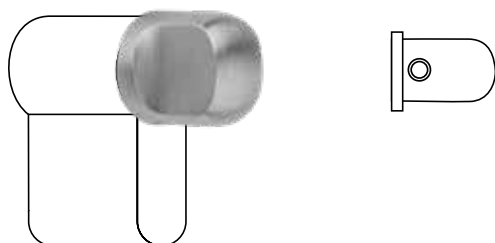

**Art. 6.0136**

Pomello per cilindro foro 8 mm.  
Cylinder knob 8 mm.

	OLV 10	OGR 10	CRS 10
FINITURA IMBALLO			

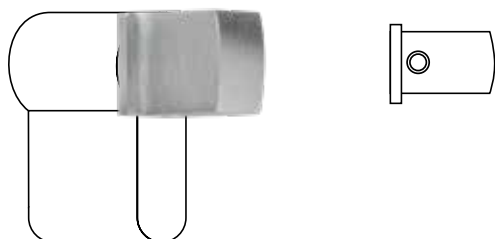

**Art. 6.0138**

Pomello quadro per cilindro foro 8 mm.  
Square cylinder knob 8 mm.

	CRS 10	CR 10
FINITURA IMBALLO		

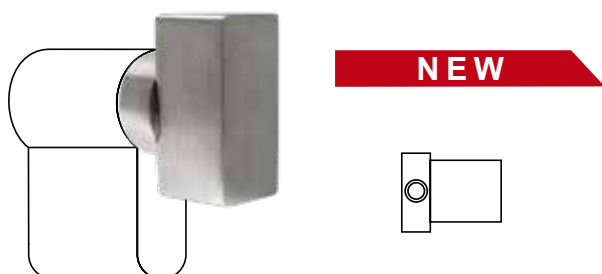

**Art. 6.0139**

Pomello rettangolare per cilindro foro 8 mm.  
Rectangular cylinder knob 8 mm.

	CRS 10
FINITURA IMBALLO	

## SPIONCINI



### Art. 9.0531

Spioncino ø 14 mm.  
Optical viewer ø 14 mm.

**9.0531.02**  
50-80 mm

**9.0531.03**  
70-120 mm

FINITURA IMBALLO	OLV 12	BZ 12	CRS 12	OLV 12	BZ 12	CRS 12



### Art. 9.0531

Spioncino quadro 30x30 mm.  
Square optical viewer 30x30 mm.

**9.0531.07**  
70-120 mm

FINITURA IMBALLO	CRS 6	CR 6

## MOSTRINE



### Art. 5.6330

Mostrina quadra 55x55 mm con sottoplastica per defender foro ø 46 mm.  
Square escutcheon for defender 55x55 mm with plastic support.

FINITURA IMBALLO	CRS 6	CR 6



### Art. 5.6331

Mostrina quadra foro yale 55x55 mm con sottoplastica.  
Square escutcheon 55x55 mm with plastic support - yale.

FINITURA IMBALLO	CRS 6	CR 6



### Art. 5.6332

Mostrina quadra doppia mappa 55x55 mm con sottoplastica.  
Square escutcheon 55x55 mm with plastic support - double bit key.

FINITURA IMBALLO	CRS 6	CR 6



### Art. 5.4330

Mostrina ovale 62x82 mm con sottoplastica per defender foro  $\varnothing$  50 mm.  
Oval escutcheon 62x82 mm for defender with plastic support.

FINITURA IMBALLO	OLV 10	OGR 10	CRS 10
---------------------	-----------	-----------	-----------

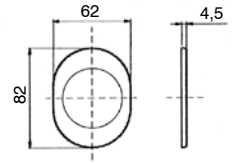

### Art. 5.4331

Mostrina ovale doppia mappa 62x82 mm con sottoplastica a pressione.  
Oval escutcheon 62x82 mm with plastic support - double bit key.

FINITURA IMBALLO	OLV 10	OGR 10	CRS 10
---------------------	-----------	-----------	-----------

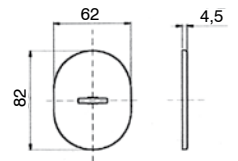

### Art. 5.4332

Mostrina ovale foro yale 62x82 mm con sottoplastica a pressione.  
Oval escutcheon 62x82 mm with plastic support - yale.

FINITURA IMBALLO	OLV 10	OGR 10	CRS 10
---------------------	-----------	-----------	-----------

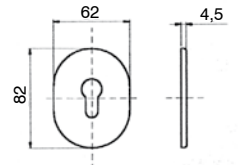

### Art. 5.4333

Mostrina ovale foro per pomello cilindro 62x82 mm con sottoplastica a pressione.  
Oval escutcheon 62x82 mm with plastic support - cylinder knob.

FINITURA IMBALLO	OLV 10	OGR 10	CRS 10
---------------------	-----------	-----------	-----------

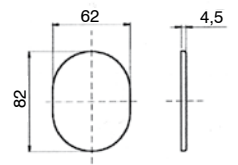

### Art. 5.4339

Mostrina ovale 62x82 mm senza foro con sottoplastica a pressione.  
Oval escutcheon 62x82 mm with plastic support - dummy.

FINITURA IMBALLO	OLV 10	OGR 10	CRS 10
---------------------	-----------	-----------	-----------

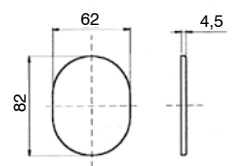





### Art. 5.4340

Mostrina ovale 70x90 mm con sottoplastica per defender foro  $\varnothing$  50 mm con viti in vista.

Oval escutcheon 70x90 mm for defender with visible screws.

FINITURA IMBALLO	OLV 10	OGR 10	CRS 10
---------------------	-----------	-----------	-----------

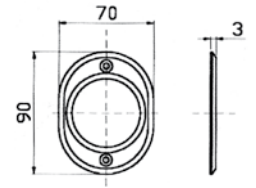

### Art. 5.4341

Mostrina ovale doppia mappa 70x90 mm con viti in vista.

Oval escutcheon 70x90 mm with visible screws - double bit key.

FINITURA IMBALLO	OLV 10	OGR 10	CRS 10
---------------------	-----------	-----------	-----------

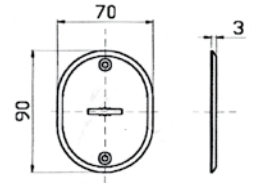

### Art. 5.4342

Mostrina ovale foro yale 70x90 mm con viti in vista.

Oval escutcheon 70x90 mm with visible screws - yale.

FINITURA IMBALLO	OLV 10	OGR 10	CRS 10
---------------------	-----------	-----------	-----------

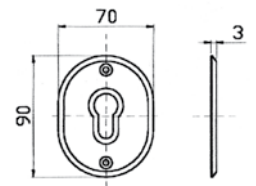

### Art. 5.4343

Mostrina ovale foro per pomello cilindro 70x90 mm con viti in vista.

Oval escutcheon 70x90 mm with visible screws - cylinder knob.

FINITURA IMBALLO	OLV 10	OGR 10	CRS 10
---------------------	-----------	-----------	-----------

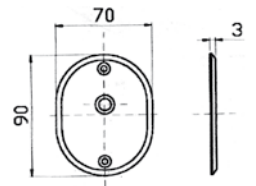

### Art. 5.4349

Mostrina ovale senza foro 70x90 mm con viti in vista.

Oval escutcheon 70x90 mm with visible screws - dummy.

FINITURA IMBALLO	OLV 10	OGR 10	CRS 10
---------------------	-----------	-----------	-----------

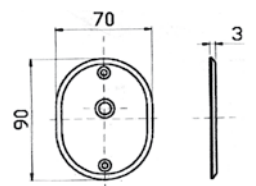



### Art. 2.9006

Bocchetta 57x70 mm per chiave doppia mappa.  
Escutcheon 57x70 mm - double bit key.

FINITURA IMBALLO	OLV 10	OGR 10	CRS 10
---------------------	-----------	-----------	-----------



### Art. 2.9006.18

Bocchetta 57x70 mm per foro yale.  
Escutcheon 57x70 mm - yale.

FINITURA IMBALLO	OLV 10	OGR 10	CRS 10
---------------------	-----------	-----------	-----------



### Art. 2.9006.32

Bocchetta 57x70 mm senza foro.  
Escutcheon 57x70 mm - dummy.

FINITURA IMBALLO	OLV 10	OGR 10	CRS 10
---------------------	-----------	-----------	-----------



### Art. 2.9020

Bocchetta rettangolare 50x63 mm per chiave, doppia mappa.  
Rectangular escutcheon 50x63 mm - double bit key.

FINITURA IMBALLO	OLV 10	OGR 10	CRS 10
---------------------	-----------	-----------	-----------



### Art. 2.9020.18

Bocchetta rettangolare 50x63 mm con foro cilindro.  
Rectangular escutcheon 50x63 mm - yale.

FINITURA IMBALLO	OLV 10	OGR 10	CRS 10
---------------------	-----------	-----------	-----------



### Art. 2.9020.32

Bocchetta rettangolare 50x63 mm senza foro.  
Rectangular escutcheon 50x63 mm - dummy.

FINITURA IMBALLO	OLV 10	OGR 10	CRS 10
---------------------	-----------	-----------	-----------



### Art. 2.9035.32

Bocchetta coprivite con sottoplastica ø 45 mm senza foro.  
Escutcheon ø 45 mm with plastic support - dummy.

FINITURA IMBALLO	OLV 10	OGR 10	CRS 10
---------------------	-----------	-----------	-----------



### Art. 2.9010

Bocchetta coprivite con sottoplastica ø 45 mm per chiave, doppia mappa.  
Escutcheon ø 45 mm with plastic support - double bit key.

FINITURA IMBALLO	OLV 10	OGR 10	CRS 10
---------------------	-----------	-----------	-----------



### Art. 2.9012

Coppia bocchetta coprivite con sottoplastica ø 45 mm per chiave, doppia mappa con copriforo.  
Pair escutcheon ø 45 mm with plastic support - double bit key with hole hider.

FINITURA IMBALLO	OLV 10	OGR 10	CRS 10
---------------------	-----------	-----------	-----------



### Art. 2.9022

Coppia bocchetta rettangolare 50x63 mm per chiave doppia mappa con copriforo.  
Pair rectangular escutcheon 50x63 mm - double bit key with hole hider.

FINITURA IMBALLO	OLV 10	OGR 10	CRS 10
---------------------	-----------	-----------	-----------



### Art. 2.9008

Coppia bocchetta 57x70 mm per chiave doppia mappa con copriforo.  
Pair escutcheon 57x70 mm - double bit key with hole hider.

FINITURA IMBALLO	OLV 10	OGR 10	CRS 10
---------------------	-----------	-----------	-----------



## Art. 6.0150

Nottolino sicurezza con rosetta tonda ø 50 mm e viti in vista.  
Safety knob round escutcheon ø 50 mm with visible screws.

FINITURA IMBALLO	OLV 10	OGR 10	CRS 10
---------------------	-----------	-----------	-----------



## Art. 6.0151

Nottolino sicurezza con rosetta ovale e viti in vista.  
Safety knob oval escutcheon with visible screws.

FINITURA IMBALLO	OLV 10	OGR 10	CRS 10
---------------------	-----------	-----------	-----------



## Art. 6.0153

Nottolino sicurezza con rosetta ovale a pressione.  
Safety knob oval pressured fixed escutcheon.

FINITURA IMBALLO	OLV 20	OGR 20	CRS 20	ALL.BR 20	ALL.ARG 20
---------------------	-----------	-----------	-----------	--------------	---------------



## Art. 6.0156

Nottolino sicurezza con rosetta ø 50 mm a pressione.  
Safety knob round pressured fixed escutcheon ø 50 mm.

FINITURA IMBALLO	OTT 20	OGR 20	CRS 20	ALL.BR 20	ALL.ARG 20
---------------------	-----------	-----------	-----------	--------------	---------------



### Art. 6.0876

Nottolino sicurezza con rosetta quadra 45x45 mm con sottoplastica.  
Safety knob square escutcheon 45x45 mm with plastic support.

FINITURA  
IMBALLO

CRS  
6

CR  
6



### Art. 6.0877

Nottolino sicurezza con rosetta quadra 50x50 mm con sottoplastica.  
Safety knob square escutcheon 50x50 mm with plastic support.

FINITURA  
IMBALLO

CRS  
6

CR  
6

## LIMITATORE A SCIVOLO



### Art. 6.0157

Limitatore di apertura a scivolo.  
Opening limiter.

FINITURA  
IMBALLO

OLV  
10

OGR  
10

CRS  
10

ALL.BR  
10

ALL.ARG  
10



**Art. 5.5330**

Placca foro maniglia e foro ø 50 mm per defender.  
Plate for handle with ø 50 mm hole for armoured protection.

FINITURA IMBALLO	OLV 10	BRG 10	CHL 10	CHS 10	PVD 10
---------------------	-----------	-----------	-----------	-----------	-----------

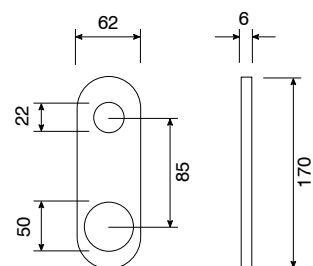

**Art. 5.5331**

Placca foro maniglia e foro doppia mappa.  
Plate for handle with double bit key hole.

FINITURA IMBALLO	OLV 10	BRG 10	CHL 10	CHS 10	PVD 10
---------------------	-----------	-----------	-----------	-----------	-----------

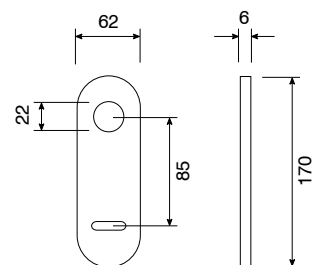

**Art. 5.5332**

Placca foro maniglia e foro yale.  
Plate for handle with yale hole.

FINITURA IMBALLO	OLV 10	BRG 10	CHL 10	CHS 10	PVD 10
---------------------	-----------	-----------	-----------	-----------	-----------

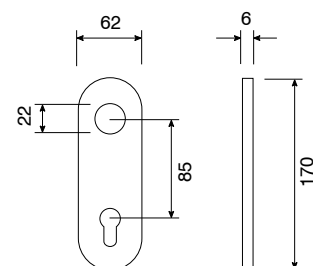

**Art. 5.5333**

Placca foro maniglia e foro ø 10,3 mm per codolo a farfalla.  
Plate for handle with ø 10,3 mm hole little knob.

FINITURA IMBALLO	OLV 10	BRG 10	CHL 10	CHS 10	PVD 10
---------------------	-----------	-----------	-----------	-----------	-----------

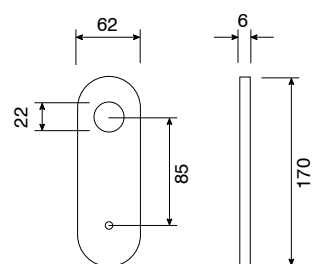



## Art. 5.4321

Protezione corazzata per cilindro  $\varnothing$  50 mm - int. 38 mm  
 disponibile h. 15/18/22/25 mm.

Defender for cylinder  $\varnothing$  50 mm - int. 38 mm - available h. 15/18/22/25 mm.

FINITURA IMBALLO	OLV 1	OGR 1	CRS 1	ALL. ARG 1	ALL. BR 1
---------------------	----------	----------	----------	---------------	--------------

**Completa di art. 5.4330.**

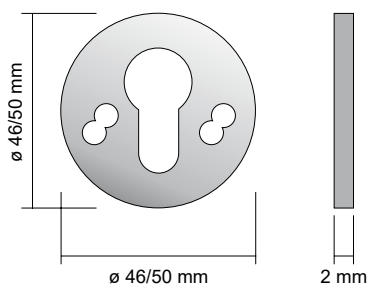
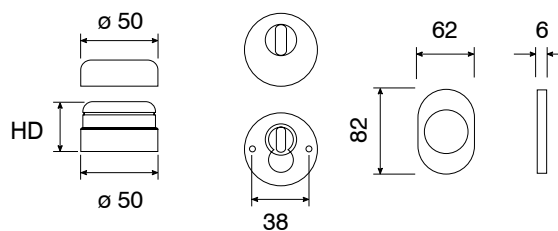

## Art. 5.4323

Spessore 2 mm per protezione cilindro - zincato.  
 Spacer for defender 2 mm - zincated.

$\varnothing$  50 mm

FINITURA  
IMBALLO

ZINCATO  
20

Cott





LINEA

# SCORREVOLI

SERIE

KIT NICCHIE

KIT SENZA SERRATURA

SERIE COPPIA

MANIGLIA AD INCASSO

SERIE MANIGLIA

AD INCASSO

SERIE

ACCESSORI



**Art. 7.5100 FZ VT N**

Kit nicchia tonda "WC" compresa serratura e maniglia di trascinamento.  
Kit round WC with lock and pull ring.

FINITURA  
IMBALLO

OTT  
1

OGR  
1

CRS  
1

CR  
1



**Art. 7.5110 FZ N**

Kit nicchia tonda "foro chiave" compresa serratura e maniglietta di trascinamento.  
Kit round KEY with lock and pull ring.

FINITURA IMBALLO	OTT 1	OGR 1	CRS 1	CR 1
---------------------	----------	----------	----------	---------



**Art. 7.5150**

Kit nicchia tonda con pendente e gettone compresa serratura e maniglietta di trascinamento.  
Kit round PENDANT with lock and pull ring.

FINITURA IMBALLO	OTT 1	CRS 1
---------------------	----------	----------



### Art. 7.5200

Kit nicchia ovale coprivite con sottoplastica "wc" compresa serratura e maniglietta di trascinamento.

Kit oval WC with lock and pull ring plastic support.

FINITURA IMBALLO	OLV 1	OGR 1	CRS 1
---------------------	----------	----------	----------



### Art. 7.5210

Kit nicchia ovale coprivite con sottoplastica "foro chiave" compresa serratura e maniglietta di trascinamento.

Kit oval KEY with lock and pull ring plastic support.

FINITURA IMBALLO	OLV 1	OGR 1	CRS 1
---------------------	----------	----------	----------



### Art. 7.5400

Kit nicchia rettangolare coprivite con sottoplastica "wc" compresa serratura e maniglietta di trascinamento.  
 Kit rectangular WC with lock and pull ring plastic support.

FINITURA IMBALLO	OLV 1	OGR 1	CRS 1
---------------------	----------	----------	----------



### Art. 7.5410

Kit nicchia rettangolare coprivite con sottoplastica "foro chiave" compresa serratura e maniglietta di trascinamento.  
 Kit rectangular KEY with lock and pull ring plastic support.

FINITURA IMBALLO	OLV 1	OGR 1	CRS 1
---------------------	----------	----------	----------



**Art. 7.5300 FZ VT N**

Kit nicchia quadra "WC" compresa serratura e maniglietta di trascinamento.  
Kit square WC with lock and pull ring.

FINITURA IMBALLO	CRS 1	CR 1
---------------------	----------	---------



**Art. 7.5310 FZ N**

Kit nicchia quadra "foro chiave" compresa serratura e maniglietta di trascinamento.  
Kit square KEY with lock and pull ring.

FINITURA IMBALLO	CRS 1	CR 1
---------------------	----------	---------



### Art. 7.5170 FZ N

Kit nicchia tonda doppio pendente compresa serratura e maniglia di trascinamento.  
Kit round DOUBLE PENDANT with lock and pull ring.

FINITURA  
IMBALLO

OTT  
1

CRS  
1



### Art. 7.5340 FZ N

Kit nicchia quadra doppio pendente compresa serratura e maniglia di trascinamento.  
Kit square DOUBLE PENDANT with lock and pull ring.

FINITURA  
IMBALLO

CRS  
1

CR  
1

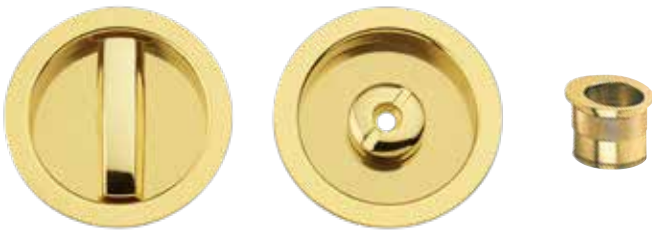

## Art. 3.2760 VT

Kit maniglia ad incasso tonda  $\varnothing$  57x12 mm per foro  $\varnothing$  48 mm WC piÙ DITALE.  
Kit WC round sliding plate  $\varnothing$  57x12 mm int  $\varnothing$  48 mm with PULL RING.

FINITURA IMBALLO	OTT 5	OGR 5	CRS 5	CR 5
---------------------	----------	----------	----------	---------



## Art. 3.2713

Kit maniglia ad incasso tonda  $\varnothing$  57x12 mm per foro  $\varnothing$  48 mm CIECA piÙ DITALE.  
Kit DUMMY round sliding plate  $\varnothing$  57x12 mm int  $\varnothing$  48 mm with PULL RING.

FINITURA IMBALLO	OTT 5	OGR 5	CRS 5	CR 5
---------------------	----------	----------	----------	---------



## Art. 3.2712

Kit maniglia ad incasso tonda  $\varnothing$  57x12 mm per foro  $\varnothing$  48 mm CHIAVE piÙ DITALE.  
Kit KEY round sliding plate  $\varnothing$  57x12 mm int  $\varnothing$  48 mm with PULL RING.

FINITURA IMBALLO	OTT 5	OGR 5	CRS 5	CR 5
---------------------	----------	----------	----------	---------





### Art. 7.5300.01 FZVTN

Coppia maniglia ad incasso quadra 52x52 mm per foro ø 48 mm WC più DITALE.  
Pair WC square sliding plate 52x52 mm int ø 48 mm with PULL RING.

FINITURA IMBALLO	CRS 5	CR 5
---------------------	----------	---------



### Art. 7.5320 FZ

Coppia maniglia ad incasso quadra 52x52 mm per foro ø 48 mm CIECA più DITALE.  
Pair DUMMY square sliding plate 52x52 mm int ø 48 mm with PULL RING.

FINITURA IMBALLO	CRS 5	CR 5
---------------------	----------	---------

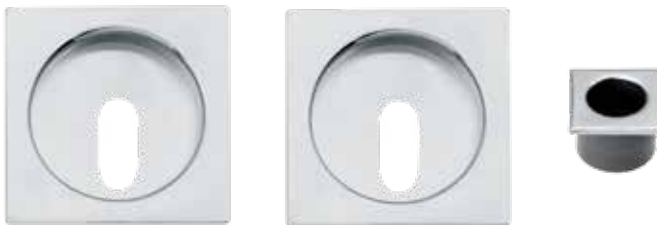

### Art. 7.5310.01 FZ

Coppia maniglia ad incasso quadra 52x52 mm per foro ø 48 mm CHIAVE più DITALE.  
Pair KEY square sliding plate 52x52 mm int ø 48 mm with PULL RING.

FINITURA IMBALLO	CRS 5	CR 5
---------------------	----------	---------



### Art. 7.5200.01

Kit maniglia ad incasso ovale 125x40 mm WC più DITALE.  
Kit WC oval sliding plate 125x40 mm with PULL RING.

FINITURA IMBALLO	OLV 5	OGR 5	CRS 5
---------------------	----------	----------	----------



### Art. 7.5220

Kit maniglia ad incasso ovale 125x40 mm CIECA più DITALE.  
Kit DUMMY oval sliding plate 125x40 mm with PULL RING.

FINITURA IMBALLO	OLV 5	OGR 5	CRS 5
---------------------	----------	----------	----------



### Art. 7.5210.01

Kit maniglia ad incasso ovale 125x40 mm CHIAVE più DITALE.  
Kit KEY oval sliding plate 125x40 mm with PULL RING.

FINITURA IMBALLO	OLV 5	OGR 5	CRS 5
---------------------	----------	----------	----------



### Art. 7.5400.01

Kit maniglia ad incasso rettangolare 125x40 mm WC più DITALE.  
Kit WC rectangular sliding plate 125x40 mm with PULL RING.

FINITURA IMBALLO	OLV 5	OGR 5	CR 5	CRS 5
---------------------	----------	----------	---------	----------



### Art. 7.5420

Kit maniglia ad incasso rettangolare 125x40 mm CIECA più DITALE.  
Kit DUMMY rectangular sliding plate 125x40 mm with PULL RING.

FINITURA IMBALLO	OLV 5	OGR 5	CR 5	CRS 5
---------------------	----------	----------	---------	----------



### Art. 7.5410.01

Kit maniglia ad incasso rettangolare 125x40 mm CHIAVE più DITALE.  
Kit KEY rectangular sliding plate 125x40 mm with PULL RING.

FINITURA IMBALLO	OLV 5	OGR 5	CR 5	CRS 5
---------------------	----------	----------	---------	----------

# SERIE COPPIA MANIGLIA AD INCASSO

ø 70 mm



## Art. 3.2732

Coppia maniglia ad incasso tonda ø 70x12 mm per foro ø 48 mm WC.  
Pair WC round sliding plate ø 70x12 mm int ø 48 mm.

FINITURA IMBALLO	Z. OTT 5	Z. CRS 5	Z. CR 5
---------------------	-------------	-------------	------------



## Art. 3.2733

Coppia maniglia ad incasso tonda ø 70x12 mm per foro ø 48 mm CIECA.  
Pair DUMMY round sliding plate ø 70x12 mm int ø 48 mm.

FINITURA IMBALLO	Z. OTT 5	Z. CRS 5	Z. CR 5
---------------------	-------------	-------------	------------



## Art. 3.2734

Coppia maniglia ad incasso tonda ø 70x12 mm per foro ø 48 mm CHIAVE.  
Pair KEY round sliding plate ø 70x12 mm int ø 48 mm.

FINITURA IMBALLO	Z. OTT 5	Z. CRS 5	Z. CR 5
---------------------	-------------	-------------	------------

**70x70 mm**



### Art. 3.2780

Coppia maniglia ad incasso quadra 70x70 mm per foro  $\varnothing$  48 mm WC.  
Pair WC square sliding plate 70x70 mm int  $\varnothing$  48 mm.

FINITURA IMBALLO	Z. OTT 5	Z. CRS 5	Z. CR 5
---------------------	-------------	-------------	------------



### Art. 3.2783

Coppia maniglia ad incasso quadra 70x70 mm per foro  $\varnothing$  48 mm CIECA.  
Pair DUMMY square sliding plate 70x70 mm int  $\varnothing$  48 mm.

FINITURA IMBALLO	Z. OTT 5	Z. CRS 5	Z. CR 5
---------------------	-------------	-------------	------------



### Art. 3.2784

Coppia maniglia ad incasso quadra 70x70 mm per foro  $\varnothing$  48 mm CHIAVE.  
Pair KEY square sliding plate 70x70 mm int  $\varnothing$  48 mm.

FINITURA IMBALLO	Z. OTT 5	Z. CRS 5	Z. CR 5
---------------------	-------------	-------------	------------

# SERIE MANIGLIA AD INCASSO

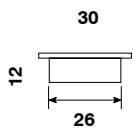

## Art. 3.2701

Maniglia ad incasso tonda senza foro.  
Sliding round handle dummy.

30x26x12 mm

FINITURA IMBALLO	OLV 20	OGR 20	CRS 20
---------------------	-----------	-----------	-----------

35x30x12 mm

FINITURA IMBALLO	OLV 20	OGR 20	CRS 20
---------------------	-----------	-----------	-----------

40x35x12 mm

FINITURA IMBALLO	OLV 20	OGR 20	CRS 20
---------------------	-----------	-----------	-----------

45x40x12 mm

FINITURA IMBALLO	OLV 20	OGR 20	CRS 20
---------------------	-----------	-----------	-----------



## Art. 3.2702

Maniglia ad incasso tonda  $\varnothing$  57x12 mm - per foro 48 mm con foro asola.  
Sliding round handle  $\varnothing$  57x12 mm - int. 48 mm key hole.

FINITURA IMBALLO	OLV 12	OGR 12	CRS 12
---------------------	-----------	-----------	-----------



## Art. 3.2704

Maniglia ad incasso tonda  $\varnothing$  57x12 mm - per foro 48 mm con foro yale.  
Sliding round handle  $\varnothing$  57x12 mm - int. 48 mm yale hole.

FINITURA IMBALLO	OLV 12	OGR 12	CRS 12
---------------------	-----------	-----------	-----------



## Art. 3.2703

Maniglia ad incasso tonda  $\varnothing$  57x12 mm - per foro 48 mm senza foro.  
Sliding round handle  $\varnothing$  57x12 mm - int. 48 mm dummy.

FINITURA IMBALLO	OLV 12	OGR 12	CRS 12
---------------------	-----------	-----------	-----------



## Art. 3.2710

Maniglia ad incasso tonda  $\varnothing$  57x12 mm - per foro 48 mm semichiusa.  
Sliding round handle  $\varnothing$  57x12 mm - int. 48 mm semiclosed dummy.

FINITURA IMBALLO	OTT 12	OGR 12	CRS 12
---------------------	-----------	-----------	-----------



### Art. 3.2985

Maniglia ad incasso ø 58 mm.  
Sliding handle ø 50 mm.

FINITURA IMBALLO	OLV 25
---------------------	-----------



### Art. 3.2980

Maniglia ad incasso 50x40 mm.  
Sliding handle 50x40 mm.

FINITURA IMBALLO	OLV 25	OGR 25	CRS 25
---------------------	-----------	-----------	-----------



### Art. 3.2722

Maniglia ad incasso quadra 52x52 mm - h. 12 mm per foro 48 mm con foro asola.  
Sliding square handle 52x52 mm - h. 12 mm - int. 48 mm - key hole.

FINITURA IMBALLO	OLV 12	CR 12	CRS 12
---------------------	-----------	----------	-----------



### Art. 3.2724

Maniglia ad incasso quadra 52x52 mm - h. 12 mm per foro 48 mm con foro yale.  
Sliding square handle 52x52 mm - h. 12 mm - int. 48 mm - yale hole.

FINITURA IMBALLO	OLV 12	CR 12	CRS 12
---------------------	-----------	----------	-----------



### Art. 3.2720

Maniglia ad incasso quadra 52x52 mm - h. 12 mm per foro 48 mm senza foro.  
Sliding square handle 52x52 mm - h. 12 mm - int. 48 mm dummy.

FINITURA IMBALLO	OLV 12	CR 12	CRS 12
---------------------	-----------	----------	-----------



### Art. 3.2721

Maniglia ad incasso quadra 52x52 mm - h. 12 mm per foro 48 mm semichiusa.  
Sliding square handle 52x52 mm - h. 12 mm - int. 48 mm semiclosed dummy.

FINITURA IMBALLO	OTT 12	OGR 12	CRS 12
---------------------	-----------	-----------	-----------



### Art. 3.2802

Maniglia ad incasso ovale con sottoplastica 152x37 mm - int. 117x22 mm con foro chiave decentrato.

Sliding oval handle with plastic support 152x37 mm - int. 117x22 mm decentralized key hole.

FINITURA IMBALLO	OLV 12	OGR 12	CRS 12

### Art. 3.2803

Maniglia ad incasso ovale con sottoplastica 152x37 mm - int. 117x22 mm senza foro.

Sliding oval handle with plastic support 152x37 mm - int. 117x22 mm dummy.

FINITURA IMBALLO	OLV 12	OGR 12	CRS 12



### Art. 3.2812

Maniglia ad incasso ovale con sottoplastica 125x40 mm - int. 80x24 mm con foro chiave centrale.

Sliding oval handle with plastic support 125x40 mm - int. 80x24 mm central key hole.

FINITURA IMBALLO	OLV 12	OGR 12	CRS 12

### Art. 3.2813

Maniglia ad incasso ovale con sottoplastica 125x40 mm - int. 80x24 mm senza foro.

Sliding oval handle with plastic support 125x40 mm - int. 80x24 mm dummy.

FINITURA IMBALLO	OLV 12	OGR 12	CRS 12





### Art. 3.2960

Maniglia ad incasso ovale Elisse 220x33 mm con foro chiave centrale.  
Sliding oval handle Elisse 220x33 mm central key hole.

FINITURA IMBALLO	OLV 12	OGR 12	CRS 12

### Art. 3.2961

Maniglia ad incasso ovale Elisse 220x33 mm senza foro.  
Sliding oval handle Elisse 220x33 mm dummy.

FINITURA IMBALLO	OLV 12	OGR 12	CRS 12



### Art. 3.2912

Maniglia ad incasso rettangolare con sottoplastica 125x40 mm - int. 80x24 mm con foro chiave centrale.  
Sliding rectangular handle 125x40 mm - int. 80x24 mm central key hole.

FINITURA IMBALLO	OLV 12	OGR 12	CRS 12

### Art. 3.2913

Maniglia ad incasso rettangolare con sottoplastica 125x40 mm - int. 80x24 mm senza foro.  
Sliding rectangular handle 125x40 mm - int. 80x24 mm dummy.

FINITURA IMBALLO	OLV 12	OGR 12	CRS 12



### Art. 3.2900

Maniglia ad incasso rettangolare 120x40 mm con foro chiave centrale.  
Sliding rectangular handle 120x40 mm central key hole.

FINITURA IMBALLO	OLV 12	OGR 12	CRS 12



### Art. 3.2901

Maniglia ad incasso rettangolare 120x40 mm senza foro.  
Sliding rectangular handle 120x40 mm dummy.

FINITURA IMBALLO	OLV 12	OGR 12	CRS 12



**Art. 7.5040**

Serratura per scorrevoli "foro chiave".  
Sliding door lock KEY.

FINITURA IMBALLO	OLV 2	BR 2	CR 2	CRS 2
---------------------	----------	---------	---------	----------

**Art. 7.5050**

Serratura per scorrevoli "wc".  
Sliding door lock WC.

FINITURA IMBALLO	OTT 2	BR 2	CR 2	CRS 2
---------------------	----------	---------	---------	----------



**Art. 7.5065**

Contropiastra per porte scorrevoli.  
Striking plate for sliding door.

FINITURA IMBALLO	OLV 10	CRS 10
---------------------	-----------	-----------



**Art. 7.5060**

Piastra copriserratura per porte scorrevoli.  
Long plate for sliding door.

FINITURA IMBALLO	OLV 10	CRS 10
---------------------	-----------	-----------



**Art. 3.2990**

Maniglia di trascinamento ditale ø 29x25 mm.  
Round pull ring ø 29x25 mm.

FINITURA IMBALLO	OTT 25	OGR 25	CRS 25
---------------------	-----------	-----------	-----------



**Art. 3.2993**

Maniglia di trascinamento ditale quadrata ø 25 - 29x28 mm.  
Square pull ring ø 25 mm - 29x28 mm.

FINITURA IMBALLO	OLV 25	OGR 25	CRS 25
---------------------	-----------	-----------	-----------

LINEA

# ACCESSORI PORTE

SERIE MANIGLIONI

PER SERRANDE

SERIE MANIGLIONI

INOX

PER ALZANTE

PORCELLANA

SERIE MANETTONCINI

SERIE BATTENTI PORTA

SERIE POMOLI FISSI

OTTONE

ZAMA

INOX

FERRO

ALLUMINIO

PLASTICA

SERIE POMOLI ACCOPPIATI

PORCELLANA

ALLUMINIO

# Cottali



**Art. 3.2625**

Maniglia diritta - int. 180 mm - ø 14 mm.  
Straight handle - int. 180 mm - ø 14 mm.

imp. 180 mm imp. 230 mm

FINITURA FINISH	FERRO NR	FERRO NR
--------------------	-------------	-------------



**Art. 3.2626**

Maniglia zancata - int. 180 mm - ø 14 mm.  
Off-set handle - int. 180 mm - ø 14 mm.

imp. 180 mm imp. 230 mm

FINITURA FINISH	FERRO NR	FERRO NR
--------------------	-------------	-------------

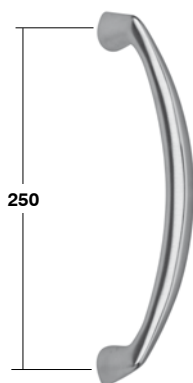

## STAR

### Art. 3.5030

Maniglione "Star" - **senza rosetta** - int. 250 mm  
 - **fissaggio slik**.  
 Star pull handle - **w/out rose slik fixing** - int. 250 mm.

SISTEMA DI FISSAGGIO SLIK

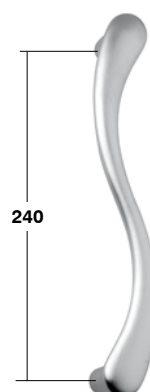

## ESSE

### Art. 3.5490

Maniglione Esse - **senza rosetta** - int. 240 mm  
 - **fissaggio slik**.  
 Esse pull handle - **w/out rose slik fixing** - int. 240 mm.

SISTEMA DI FISSAGGIO SLIK



FINITURA  
IMBALLO

OLV  
2

OGR  
2

CRS  
2

FINITURA  
IMBALLO

OLV  
2

OGR  
2

CRS  
2

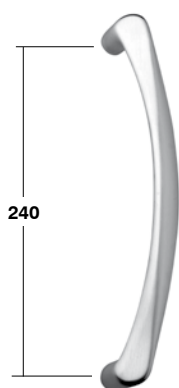

## ARCO

### Art. 3.5670

Maniglione Arco - **senza rosetta** int. 240 mm  
- **fissaggio slik.**

Arco pull handle - **w/out rose slik fixing** - int. 240 mm.

SISTEMA DI FISSAGGIO SLIK



## COSMO

### Art. 3.5930

Maniglione **zama** Cosmo completo di kit di montaggio - int. 205 mm.

Cosmo pull handle complete with fixing accessories - int. 205 mm - **zamak.**

FINITURA  
IMBALLO

OLV  
2

OGR  
2

CRS  
2

FINITURA  
IMBALLO

Z. CRS  
2

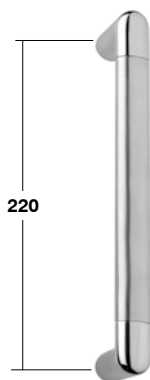

## ELLY

### Art. 3.5480

Maniglione Elly Bic - **senza rosetta** int. 220 mm - **fissaggio slik.**

Elly Bic pull handle - **w/out rose slik fixing** - int. 220 mm.

SISTEMA DI FISSAGGIO SLIK



FINITURA IMBALLO	OLV/SAT	CR/CRS
	2	2

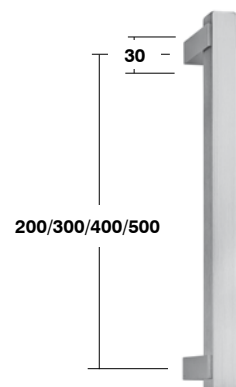

## LOTUS

### Art. 3.5910

Maniglione Lotus - **senza rosetta** fissaggio slik. Lotus pull handle - **w/out rose slik fixing.**

int. 200 mm int. 300 mm int. 400 mm int. 500 mm

SISTEMA DI FISSAGGIO SLIK



FINITURA IMBALLO	CR/CRS	CR/CRS	CR/CRS	CR/CRS
	2	2	2	2



200/300/400/500



## KUBIK

### Art. 3.5920

Maniglione Kubik - **senza rosetta**  
fissaggio slik.  
Kubik pull handle - **w/out rose slik fixing.**

SISTEMA DI FISSAGGIO SLIK



int. 200 mm    int. 300 mm    int. 400 mm    int. 500 mm

FINITURA IMBALLO	CR/CRS 2	CR/CRS 2	CR/CRS 2	CR/CRS 2
---------------------	-------------	-------------	-------------	-------------



223

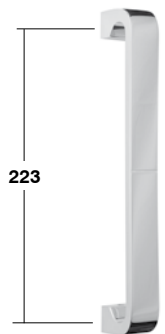

## LAMBO

### Art. 3.5950

Maniglione Lambo - **senza rosetta** int. 223 mm  
- **fissaggio slik.**  
Lambo pull handle - **w/out rose slik fixing** - int. 223  
mm.

SISTEMA DI FISSAGGIO SLIK



FINITURA IMBALLO	CR 2	CRS 2
---------------------	---------	----------



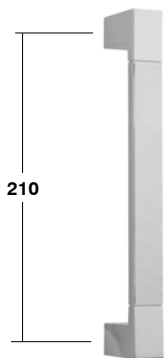

## ELLE BIC

### Art. 3.5970 BIC

Maniglione **zama** Elle Bic - **senza rosetta** int. 210 mm - **fissaggio slik**.  
 Elle Bic pull handle - **w/out rose slik fixing** - int. 210 mm - **zamak**.

SISTEMA DI FISSAGGIO SLIK



## ELLE

### Art. 3.5970

Maniglione **zama** Elle - **senza rosetta** - int. 210 mm - **fissaggio slik**.  
 Elle pull handle - **w/out rose slik fixing** - int. 210 mm - **zamak**.

SISTEMA DI FISSAGGIO SLIK



FINITURA  
IMBALLO

CR/CRS  
2

FINITURA  
IMBALLO

CR  
2

CRS  
2

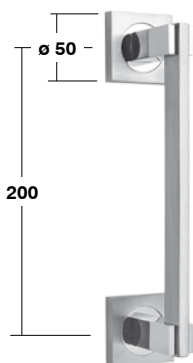

## LAURA

### Art. 3.5533

Maniglione Laura con rosetta quadra 50X50 mm - int. 200 mm.  
 Laura pull handle - square rose 50x50 mm - int. 200.

FINITURA IMBALLO	CR/CRS 2
---------------------	-------------

### Art. 3.5530 SL

Maniglione Laura - **senza rosetta**  
**fissaggio slik.**  
 Laura pull handle - **w/out rose slik** fixing.

SISTEMA DI FISSAGGIO SLIK



int. 200 mm   int. 250 mm   int. 300 mm   int. 400 mm   int. 500 mm

FINITURA IMBALLO	CR/CRS 2	CR/CRS 2	CR/CRS 2	CR/CRS 2	CR/CRS 2
---------------------	-------------	-------------	-------------	-------------	-------------

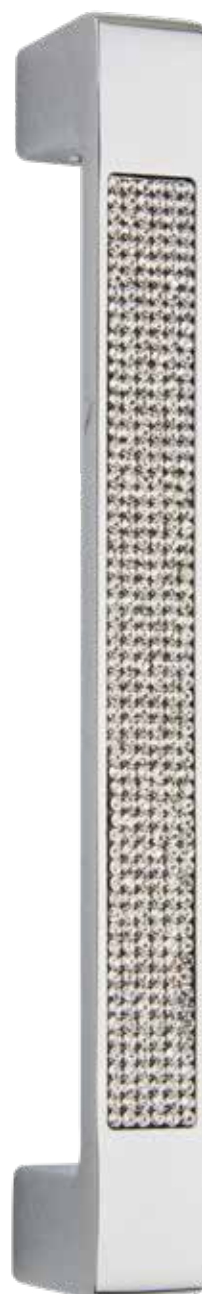

## LIGHT

### Art. 3.5500

Maniglione zama Light - **senza rosetta** - int. 210 mm  
 - **fissaggio slik.**  
 Light pull handle - **w/out rose slik** fixing - int. 210 mm  
 - **zamak.**

SISTEMA DI FISSAGGIO SLIK



FINITURA IMBALLO	CR/KR 2
---------------------	------------

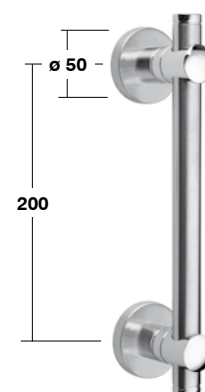
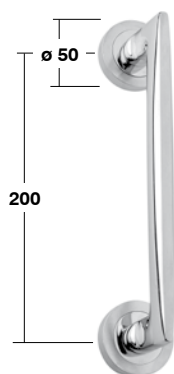

**CRIS**

**PILAR**

**Art. 3.5680**

Maniglione Pilar con rosetta ø 50 mm ad avvitare - int. 200 mm.  
Pilar pull handle - ø 50 mm screwed rose - int. 200 mm.

**Art. 3.5540**

Maniglione Cris inox - rosetta ø 50 mm a pressione int. 200 mm - ø 19 mm.  
Cris pull handle - ø 50 mm pressure fixed rose - int. 200 mm - ø 19 mm.

**Art. 3.5680 SL**  
senza rosetta - slik

FINITURA IMBALLO	OLV 2	CR/CRS 2	OLV 2	CR/CRS 2
---------------------	----------	-------------	----------	-------------

FINITURA IMBALLO	NIK/CR 2	PVD/ORO 2
---------------------	-------------	--------------

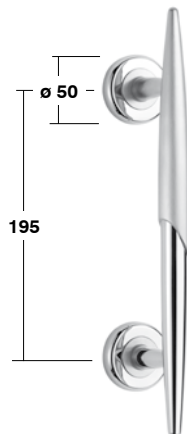

## LUXOR

### Art. 3.5450

Maniglione Luxor - rosetta  $\varnothing$  50 mm ad avvitare - int. 195 mm.  
Luxor pull handle -  $\varnothing$  50 mm screwed rose - int. 195 mm.

FINITURA IMBALLO	OLV/SAT 2	CR/CRS 2
---------------------	--------------	-------------



## PEGASO

### Art. 3.5400

Maniglione Pegaso - rosetta  $\varnothing$  50 mm ad avvitare - int. 250 mm.  
Pegaso pull handle -  $\varnothing$  50 mm screwed rose - int. 250 mm.

FINITURA IMBALLO	OLV 2	OGR 2	CRS 2
---------------------	----------	----------	----------

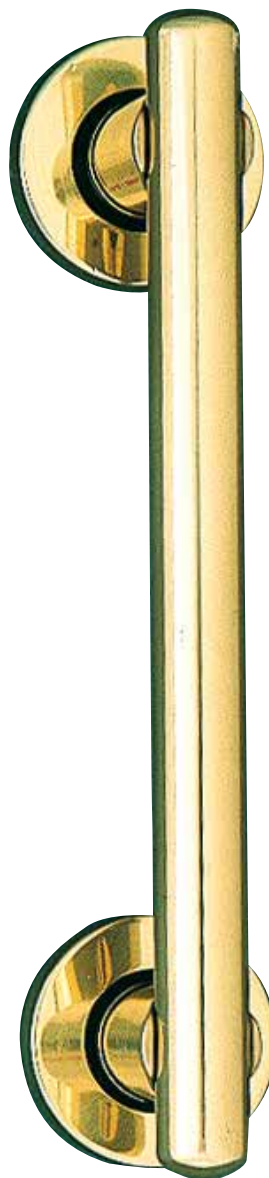

## CAPRI

### Art. 3.5000

Maniglione Capri diritto - rosetta  $\varnothing$  50 mm ad avvitare - int. 170 mm.  
Capri pull handle -  $\varnothing$  50 mm screwed rose - int. 170 mm.

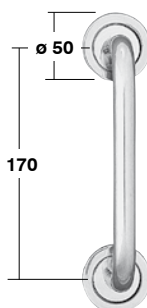

## IBIZA

### Art. 3.5020

Maniglione Ibiza diritto - rosetta  $\varnothing$  45 mm a pressione.  
Ibiza pull handle -  $\varnothing$  45 mm pressure fixed rose.

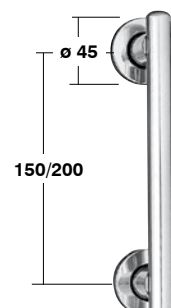

int. 150 mm

int. 200 mm

FINITURA  
IMBALLO

OLV  
2

OGR  
2

FINITURA  
IMBALLO

OLV  
2

CRS  
2

OLV  
2

CRS  
2

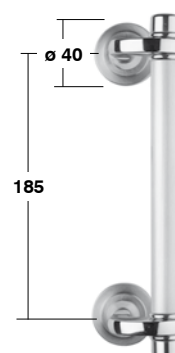
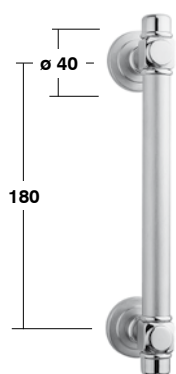

## PIREO

### Art. 3.5140

Maniglione Pireo - int. 180 mm - rosetta  $\varnothing$  40 mm perno filettato oppure rosetta  $\varnothing$  45 mm sottoplastica.

Pireo pull handle -  $\varnothing$  40 mm rose w/stud or  $\varnothing$  45 mm pressure fixed rose - int. 180 mm.

bicolore

FINITURA IMBALLO	OLV/SAT 2	CR/CRS 2
---------------------	--------------	-------------

## PIREO ZANCATO

### Art. 3.5470

Maniglione Pireo zancato - int. 180 mm - rosetta  $\varnothing$  40 mm perno filettato oppure rosetta  $\varnothing$  45 mm sottoplastica.

Pireo off-set pull handle -  $\varnothing$  40 mm rose w/stud or  $\varnothing$  45 mm pressure fixed rose - int. 180 mm.

bicolore

FINITURA IMBALLO	OLV/SAT 2	CR/CRS 2
---------------------	--------------	-------------

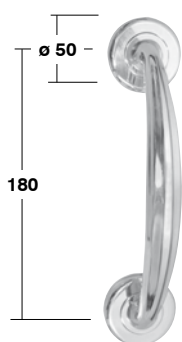

## SILVIA

## CLARA

### Art. 3.5370

Maniglione Silvia dritto rigato - rosetta  $\varnothing$  50 mm ad avvitare - int. 180 mm.  
Silvia striped pull handle -  $\varnothing$  50 mm screwed rose - int. 180 mm.

### Art. 3.5360

Maniglione Clara dritto - rosetta  $\varnothing$  50 mm ad avvitare - int. 180 mm.  
Clara pull handle -  $\varnothing$  50 mm screwed rose - int. 180 mm.

FINITURA  
IMBALLO

OLV  
2

OGR  
2

CRS  
2

FINITURA  
IMBALLO

OLV  
2

OGR  
2

CRS  
2

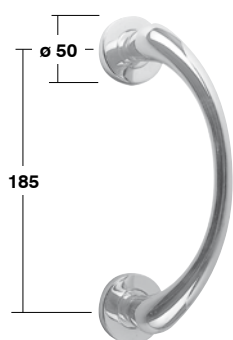

## DESY

## DESY RIGATO

### Art. 3.5230

Maniglione Desy - rosetta  $\varnothing$  50 mm ad avvitare - int. 185 mm.  
Desy pull handle -  $\varnothing$  50 mm screwed rose - int. 185 mm.

### Art. 3.5290

Maniglione Desy rigato - rosetta  $\varnothing$  50 mm ad avvitare - int. 185 mm.  
Desy striped pull handle -  $\varnothing$  50 mm scewed rose - int. 185 mm.

FINITURA IMBALLO	OLV 2	OGR 2	CRS 2
---------------------	----------	----------	----------

FINITURA IMBALLO	OLV 2	OGR 2	CRS 2
---------------------	----------	----------	----------





## SAMBA

### Art. 3.5660

Maniglione Samba con rosetta  $\varnothing$  50 mm ad avvitare - int. 195 mm.  
Samba pull handle -  $\varnothing$  50 mm screwed rose - int. 195 mm.

FINITURA IMBALLO	OLV 2	SAT 2	CRS 2
---------------------	----------	----------	----------

### Art. 3.5660 SL

Maniglione Samba - **senza rosetta** int. 195 mm  
- **fissaggio slik.**  
Samba pull handle - **w/out rose slik fixing** - int. 195 mm.

SISTEMA DI FISSAGGIO SLIK



FINITURA IMBALLO	OLV 2	SAT 2	CRS 2
---------------------	----------	----------	----------

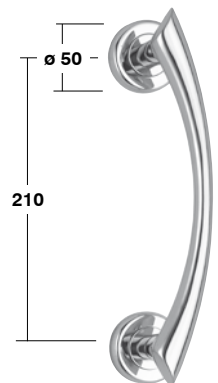

## COMETA

### Art. 3.5330

Maniglione Cometa - rosetta  $\varnothing$  50 mm ad avvitare - int. 210 mm.  
Cometa handle -  $\varnothing$  50 mm screwed rose - int. 210 mm.

FINITURA IMBALLO	OLV 2	OGR 2	CRS 2
---------------------	----------	----------	----------

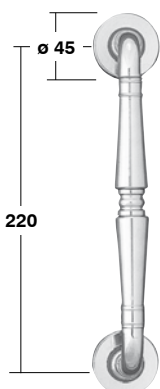

## VENEZIA

### Art. 3.5080

Maniglione Venezia diritto - rosetta  $\varnothing$  45 mm a pressione - int. 220 mm.  
Venezia pull handle -  $\varnothing$  45 mm pressure fixed rose - int. 220 mm.

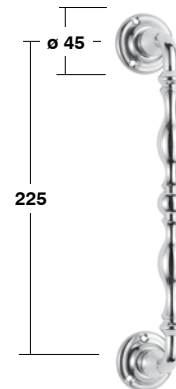

## LYON

### Art. 3.5612

Maniglione Lyon - rosetta artistica  $\varnothing$  45 - viti in vista - int. 225 mm.  
Lyon pull handle -  $\varnothing$  45 mm artistic rose w/visible screws - int. 225 mm.

FINITURA IMBALLO	OLV 2	ANT.BL 2	ARG ANT 2
---------------------	----------	-------------	--------------

FINITURA IMBALLO	OLV 2	ANT BL 2	CRS 2	ORO ANT 2	ARG ANT 2
---------------------	----------	-------------	----------	--------------	--------------



## CORINNE

### Art. 3.5412

Maniglione Corinne - rosetta artistica  $\varnothing$  45 mm - viti in vista - int. 225 mm.  
Corinne pull handle -  $\varnothing$  45 mm artistic rose w/visible screws - int. 225 mm.

FINITURA IMBALLO	OLV 2	ANT BL 2	CRS 2	ORO ANT 2	ARG ANT 2
---------------------	----------	-------------	----------	--------------	--------------

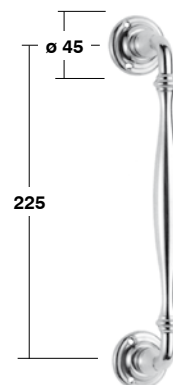

## LIBERTY

### Art. 3.5512

Maniglione Liberty - rosetta artistica  $\varnothing$  45 mm - viti in vista - int. 225 mm.  
Liberty handle -  $\varnothing$  45 mm artistic rose w/visible screws - int. 225 mm.

FINITURA IMBALLO	OLV 2	ANT BL 2	CRS 2	ORO ANT 2	ARG ANT 2
---------------------	----------	-------------	----------	--------------	--------------



## RICCIO

### Art. 3.5640

Maniglione Riccio - rosetta  $\varnothing$  50 mm ad avvitare - int. 245 mm.  
Riccio pull handle -  $\varnothing$  50 mm screwed rose - int. 245 mm.

FINITURA IMBALLO	OLV 2	OGR 2	CRS 2
---------------------	----------	----------	----------



## GEA

### Art. 3.5960

Maniglione Gea - rosetta  $\varnothing$  50 mm ad avvitare- int. 210 mm.  
Gea pull handle -  $\varnothing$  50 mm screwed rose - int. 210 mm.

FINITURA IMBALLO	OLV 2	OGR OP 2	CRS 2
---------------------	----------	-------------	----------

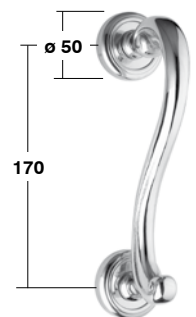

## GARDA

## EOS

### Art. 3.5260

Maniglione Garda - rosetta  $\varnothing$  45 mm ad avvitare - int. variabile da 170 a 205 mm.  
Garda pull handle -  $\varnothing$  45 mm screwed rose - int. from 170 to 205 mm.

### Art. 3.5659

Maniglione Eos - rosetta  $\varnothing$  50 mm con bordo - int. 170 mm.  
Eos pull handle -  $\varnothing$  50 mm edged rose - int. 170 mm.

FINITURA  
IMBALLO

OLV  
2

OGR  
2

FINITURA  
IMBALLO

OLV  
2

ORO ANT  
2

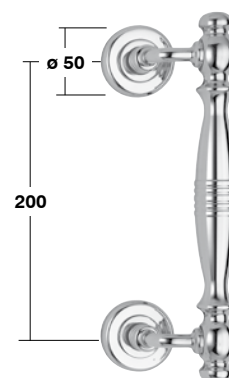
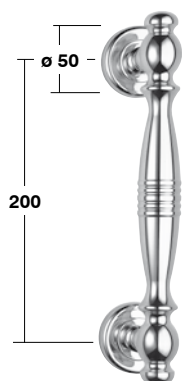

## PORTO

### Art. 3.5340

Maniglione Porto diritto - rosetta  $\varnothing$  50 mm ad avvitare - int. 200 mm.  
 Porto pull handle -  $\varnothing$  50 mm screwed rose - int. 200 mm.

## PORTO ZANCATO

### Art. 3.5350

Maniglione Porto zancato - rosetta  $\varnothing$  50 mm ad avvitare - int. 200 mm.  
 Porto decentralized pull handle -  $\varnothing$  50 mm screwed rose - int. 200 mm.

FINITURA  
 IMBALLO

OLV  
 2

OGR  
 2

FINITURA  
 IMBALLO

OLV  
 2

OGR  
 2

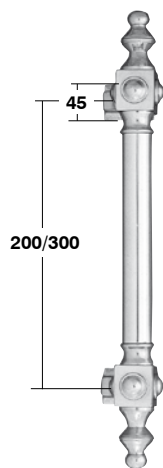

## IMPERO

### Art. 3.5050

Maniglione Impero.  
Impero pull handle.

int. 200 mm

int. 300 mm

FINITURA IMBALLO	OLV 2	OGR 2	OLV 2	OGR 2
---------------------	----------	----------	----------	----------

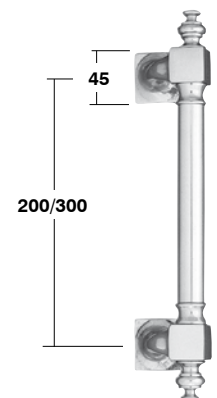

## URANO

### Art. 3.5060

Maniglione Urano.  
Urano pull handle.

int. 200 mm

int. 300 mm

FINITURA IMBALLO	OLV 2	OGR 2	OLV 2	OGR 2
---------------------	----------	----------	----------	----------

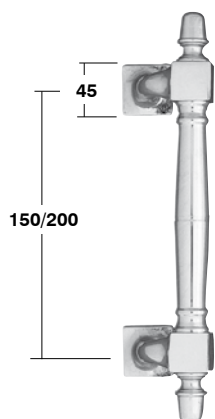

## RODI

### Art. 3.5070

Maniglione Rodi.  
Rodi pull handle.

int. 150 mm

int. 200 mm

FINITURA IMBALLO	OLV 2	OGR 2	OLV 2	OGR 2
---------------------	----------	----------	----------	----------

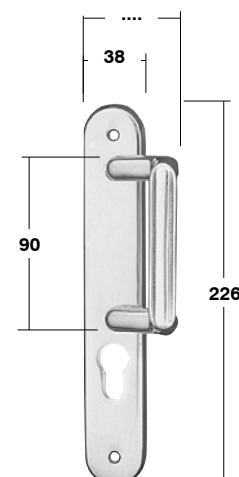
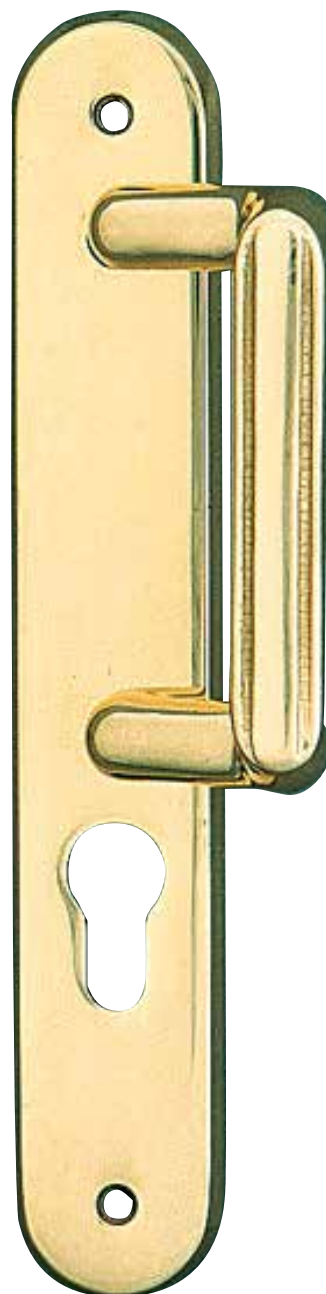

## BRIGI ZANCATO

### Art. 3.5040

Maniglione Brigi decentrato - placca 226x38 cm foro yale - dx/sx.  
Brigi off-set pull handle - yale plate 226x38 cm - dx/sx.

FINITURA IMBALLO	OLV 2
---------------------	----------



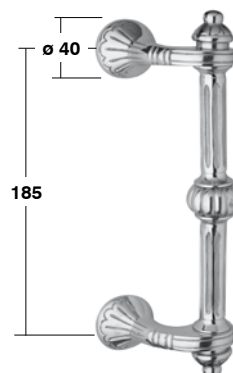
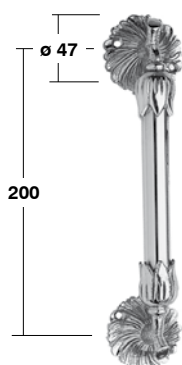

## FLOWER

### Art. 3.5270

Maniglione Flower - int. 200 mm.  
Flower pull handle - int. 200 mm.

## THAY

### Art. 3.5380

Maniglione Thay - int. 185 mm.  
Thay pull handle - int. 185 mm.

FINITURA  
IMBALLO

OLV  
2

FINITURA  
IMBALLO

OLV  
2

# SERIE MANIGLIONI INOX



## Art. 9.0300

Kit imballaggio per maniglione singolo.

IMBALLO 1

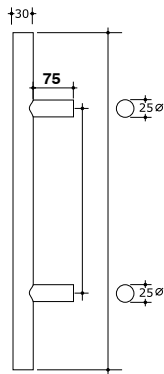

## Art. 9.0310

Kit imballaggio per maniglione doppio con guarnizione per vetro.

IMBALLO 1

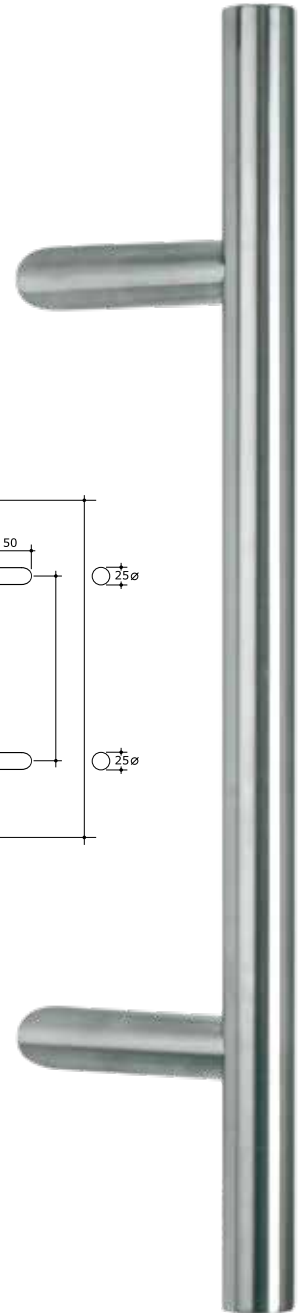
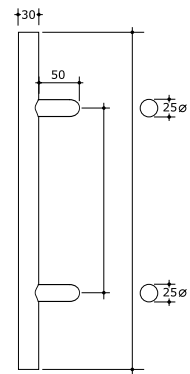

## Art. 3.5770

Maniglione linea **dritto** - con possibilità di lunghezze speciali su richiesta AISI 304. Linea pull handle w/special measure available on request AISI 304.

	int. 210 mm lungh. 300 mm	int. 300 mm lungh. 400 mm	int. 300 mm lungh. 500 mm
FINITURA	INOX SAT	INOX SAT	INOX SAT
IMBALLO	2	2	2
	int. 400 mm lungh. 600 mm	int. 600 mm lungh. 800 mm	int. 900 mm lungh. 1200 mm
FINITURA	INOX SAT	INOX SAT	INOX SAT
IMBALLO	2	2	2

## Art. 3.5780

Maniglione linea **decentrato** con possibilità di lunghezze speciali su richiesta AISI 304. Linea off-set pull handle w/special measure available on request AISI 304.

	int. 210 mm lungh. 300 mm	int. 300 mm lungh. 400 mm	int. 300 mm lungh. 500 mm
FINITURA	INOX SAT	INOX SAT	INOX SAT
IMBALLO	2	2	2
	int. 400 mm lungh. 600 mm	int. 600 mm lungh. 800 mm	int. 900 mm lungh. 1200 mm
FINITURA	INOX SAT	INOX SAT	INOX SAT
IMBALLO	2	2	2



### Art. 9.0300

Kit imballaggio per maniglione singolo.

IMBALLO	1
---------	---



### Art. 9.0310

Kit imballaggio per maniglione doppio con guarnizione per vetro.

IMBALLO	1
---------	---



### Art. 3.5990

Maniglione Axel **dritto** 25x25 cm con possibilità di lunghezze speciali su richiesta AISI 304.

Axel pull handle 25x25 cm w/special measure available on request AISI 304.

	int. 210 mm lungh. 300 mm	int. 300 mm lungh. 400 mm	int. 300 mm lungh. 500 mm
FINITURA	INOX SAT	INOX SAT	INOX SAT
IMBALLO	2	2	2
	int. 400 mm lungh. 600 mm	int. 600 mm lungh. 800 mm	int. 900 mm lungh. 1200 mm
FINITURA	INOX SAT	INOX SAT	INOX SAT
IMBALLO	2	2	2

### Art. 3.5980

Maniglione Axel **decentrato** 25x25 cm con possibilità di lunghezze speciali su richiesta AISI 304.

Axel off-set pull handle 25x25 cm w/special measure available on request AISI 304.

	int. 210 mm lungh. 300 mm	int. 300 mm lungh. 400 mm	int. 300 mm lungh. 500 mm
FINITURA	INOX SAT	INOX SAT	INOX SAT
IMBALLO	2	2	2
	int. 400 mm lungh. 600 mm	int. 600 mm lungh. 800 mm	int. 900 mm lungh. 1200 mm
FINITURA	INOX SAT	INOX SAT	INOX SAT
IMBALLO	2	2	2



## NOVANTA

### Art. 3.5700

Maniglione Novanta - rosetta  $\varnothing$  50 mm a pressione AISI 304.

Novanta pull handle -  $\varnothing$  50 mm pressure fixed rose AISI 304.

int. 200 mm      int. 250 mm

FINITURA IMBALLO	INOX SAT 2	INOX SAT 2
---------------------	---------------	---------------



## OLARIX

### Art. 3.5790

Maniglione Olarix - rosetta  $\varnothing$  50 mm a pressione AISI 304.

Olarix pull handle -  $\varnothing$  50 mm pressure fixed rose AISI 304.

int. 200 mm      int. 250 mm

FINITURA IMBALLO	INOX SAT 2	INOX SAT 2
---------------------	---------------	---------------



## AXEL

### Art. 3.5995

Maniglione Axel - rosetta 50x50 mm a pressione AISI 304.

Axel pull handle - 50x50 mm pressure fixed rose AISI 304.

int. 200 mm      int. 250 mm

FINITURA IMBALLO	INOX SAT 2	INOX SAT 2
---------------------	---------------	---------------



### Art. 3.5710.OIS

Maniglione singolo **diritto** - ø 32x350x1,5 mm AISI 304.  
Single pull handle - ø 32 mm - 1,5 mm thickness - int. 350 mm AISI 304.

FINITURA  
IMBALLO

INOX SAT  
2



### Art. 3.5720.OIS

Maniglione singolo **decentrato** - ø 32x350x1,5 mm AISI 304.  
Single off-set pull handle - ø 32 mm - 1,5 mm thickness - int. 350 mm AISI 304.

FINITURA  
IMBALLO

INOX SAT  
2



### Art. 3.5760.OIS

Maniglione singolo - ø 32 x 490 x 1,5 mm - int. 350 mm AISI 304.  
Single pull handle - ø 32 mm - 1,5 mm thickness - 490 mm length - int. 350 mm AISI 304.

FINITURA  
IMBALLO

INOX SAT  
2



### Art. 3.5730.OIS

Maniglione singolo -  $\varnothing$  32 x 350 x 1,5 mm AISI 304.  
Single pull handle -  $\varnothing$  32 mm - 1,5 mm thickness - int. 350 mm AISI 304.

FINITURA  
IMBALLO

INOX SAT  
2



### Art. 3.5750.OIS

Maniglione singolo -  $\varnothing$  32 x 350 x 1,5 mm AISI 304.  
Single pull handle -  $\varnothing$  32 mm - 1,5 mm thickness - int. 350 mm AISI 304.

FINITURA  
IMBALLO

INOX SAT  
2

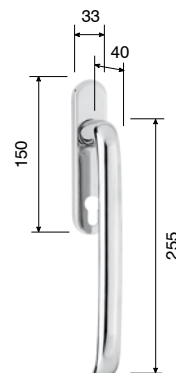

**Art. 3.5800**

Coppia maniglione a scatto per alzanti scorrevoli - int. 85 mm.  
 Pair pull handle for patio doors - int. 85 mm.

FINITURA  
 IMBALLO

OLV  
 1

CRS  
 1

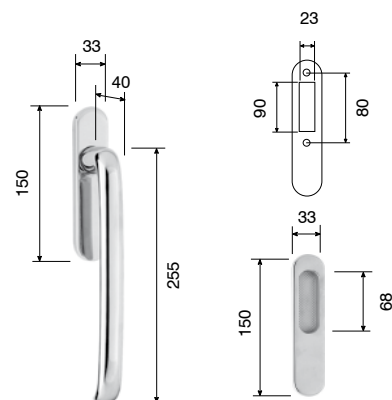

**Art. 3.5900**

Maniglione singolo a scatto per alzanti scorrevoli singoli - int. 85 mm.  
 Single pull handle for patio doors - int. 85 mm.

FINITURA  
 IMBALLO

OLV  
 2

CRS  
 2



**Art. 3.5870**

Coppia maniglione "Elle" a scatto per scorrevole.  
Sliding door pull handle "Elle" - pair.

FINITURA	CRS
IMBALLO	1

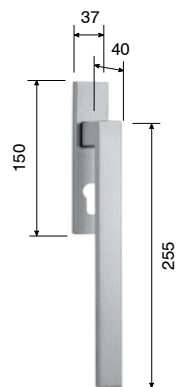

**Art. 3.5810**

Maniglione singolo "Elle" a scatto per scorrevole.  
Sliding door pull handle "Elle" - single.

FINITURA	CRS
IMBALLO	2

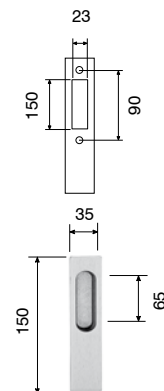
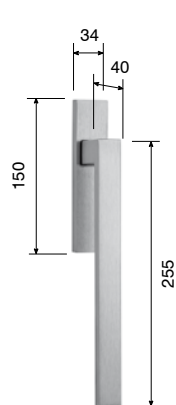

**Art. 3.5870 BIC**

Coppia maniglione "Elle Bic" a scatto per scorrevole.  
Sliding door pull handle "Elle Bic" - pair.

FINITURA	CR/CRS
IMBALLO	1

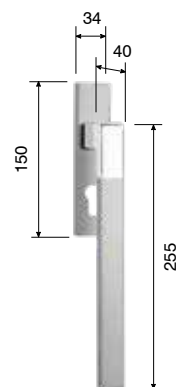

**Art. 3.5810 BIC**

Maniglione singolo "Elle Bic" a scatto per scorrevole.  
Sliding door pull handle "Elle Bic" - single.

FINITURA	CR/CRS
IMBALLO	2

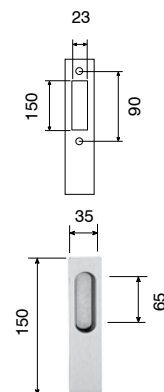
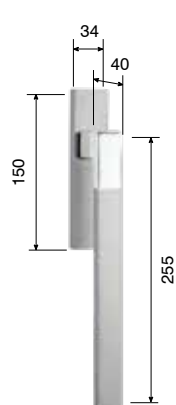





### Art. 3.5850

Coppia maniglione "Mito" a scatto per alzante scorrevole.  
Sliding door pull handle "Mito" - pair.

FINITURA IMBALLO	OTT	CRS
---------------------	-----	-----

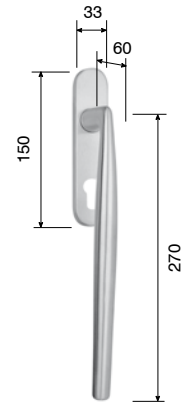

### Art. 3.5890

Maniglione singolo "Mito" a scatto per alzante scorrevole.  
Sliding door pull handle "Mito" - single.

FINITURA IMBALLO	OTT	CRS
---------------------	-----	-----

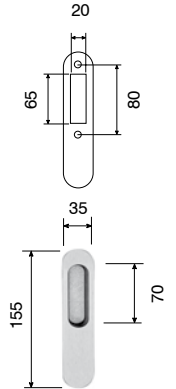
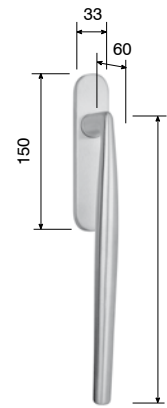

## LINEA ALLUMINIO



### Art. 3.5830

Coppia maniglione alluminio a scatto per alzante scorrevole.  
Aluminium sliding door pull handle - pair.

FINITURA IMBALLO	ALL.BR	ALL.ARG
---------------------	--------	---------

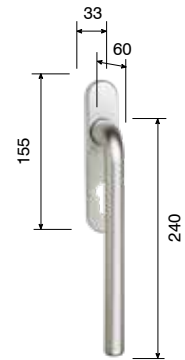

### Art. 3.5840

Maniglione singolo alluminio a scatto per alzante scorrevole.  
Aluminium sliding door pull handle - single.

FINITURA IMBALLO	ALL.BR	ALL.ARG
---------------------	--------	---------

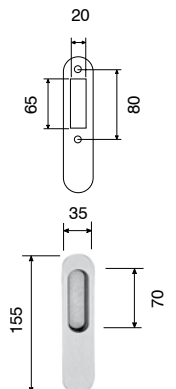
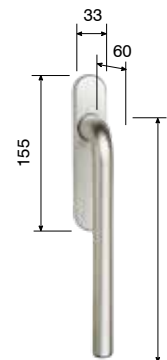

# SERIE MANIGLIONI PORCELLANA



## Art. 3.5165

Maniglione Sonia in porcellana bianca rosetta Lux ø 45 mm.  
Sonia pull handle white porcelain ø 45 mm Lux rose.

	int. 140 mm	int. 140 mm	int. 225 mm	int. 225 mm
FINITURA	OLV	ANT BL	OLV	ANT BL
IMBALLO	2	2	2	2



## Art. 3.5175

Maniglione Gemma in porcellana champagne decorata - rosetta Lux ø 45 mm.  
Gemma pull handle decorated champagne porcelain ø 45 mm Lux rose.

	int. 140 mm	int. 140 mm	int. 225 mm	int. 225 mm
FINITURA	OLV	ANT BL	OLV	ANT BL
IMBALLO	2	2	2	2



### Art. 3.5185

Maniglione Lara in porcellana champagne con rosetta Lux ø 45 mm.  
Lara pull handle champagne porcelain ø 45 mm Lux rose.

	int. 140 mm	int. 140 mm	int. 225 mm	int. 225 mm
FINITURA IMBALLO	OLV 2	ANT BL 2	OLV 2	ANT BL 2



### Art. 3.5195

Maniglione Anna in porcellana bianca decorata - rosetta Lux ø 45 mm.  
Anna pull handle decorated white porcelain ø 45 mm Lux rose.

	int. 140 mm	int. 140 mm	int. 225 mm	int. 225 mm
FINITURA IMBALLO	OLV 2	ANT BL 2	OLV 2	ANT BL 2



### Art. 3.5325

Maniglione Sonia Blu in porcellana bianca decorata c/fiore blu rosetta Lux ø 45 mm.  
Sonia Blu pull handle decorated white porcelain ø 45 mm Lux rose.

	int. 140 mm	int. 140 mm	int. 225 mm	int. 225 mm
FINITURA IMBALLO	OLV 2	ANT BL 2	OLV 2	ANT BL 2

# SERIE MANETTONCINI



## Art. 3.2690.16

Manettoncino Slik - int. 160 mm - **fissaggio slik.**  
Slik pull handle - **slik fixing** - int. 160 mm.

SISTEMA DI FISSAGGIO SLIK



FINITURA IMBALLO	OTT 6	OGR 6	CRS 6
---------------------	----------	----------	----------

## Art. 3.2690.20

Manettoncino Slik - int. 200 mm - **fissaggio slik.**  
Slik pull handle - **slik fixing** - int. 200 mm.

SISTEMA DI FISSAGGIO SLIK



FINITURA IMBALLO	OTT 6	OGR 6	CRS 6
---------------------	----------	----------	----------



## Art. 3.2550

Manettoncino Gaudel - rosetta ø 40 mm - int. 150 mm.  
Gaudel pull handle - ø 40 mm rose - int. 150 mm.

FINITURA IMBALLO	OLV 6	OGR 6	CRS 6	ORO ANT 6
---------------------	----------	----------	----------	--------------



### Art. 3.5630

Manettoncino Clara - int. 200 mm - **fissaggio slik.**  
Clara pull handle - **slik fixing** - int. 200 mm.

SISTEMA DI FISSAGGIO SLIK



### Art. 3.5620

Manettoncino Flexa - int. 200 mm - **fissaggio slik.**  
Flexa pull handle - **slik fixing** - int. 200 mm.

SISTEMA DI FISSAGGIO SLIK



FINITURA  
IMBALLO

OTT  
6

OGR  
6

CR  
6

CRS  
6

FINITURA  
IMBALLO

OLV  
6

OGR  
6

CRS  
6



### Art. 3.5430

Manettoncino Iber - int. 200 mm - **fissaggio slik.**  
Iber pull handle - **slik fixing** - int. 200 mm.

SISTEMA DI FISSAGGIO SLIK



FINITURA IMBALLO	OLV 6	OGR 6	CRS 6
---------------------	----------	----------	----------



### Art. 3.2670

Manettoncino Nike - placca sagomata 102x48 mm.  
Nike pull handle - shaped plate 102x48 mm.

FINITURA IMBALLO	OLV 2	ANT 2
---------------------	----------	----------



**Art. 7.4210**

Battente Maxi Leone ø 200 mm con perno passante.  
Maxi Lion door knocker ø 200 mm with through screw.

FINITURA  
IMBALLO

OLV  
1

ORO ANT  
1



ø 200



**Art. 7.4014**

Battente Leone 190x105 mm.  
Lion door knocker 190x105 mm.

FINITURA IMBALLO	OLV 2	ANT BL 2
---------------------	----------	-------------



**Art. 7.4013**

Battente Leoncino 160x90 mm con perno passante.  
Leoncino door knocker 160x90 mm with through screw.

FINITURA IMBALLO	OLV 2	ANT BL 2
---------------------	----------	-------------







### Art. 7.4015

Battente Leone 200x100 mm con perno passante.  
Leone door knocker 200x100 mm with through screw.

FINITURA IMBALLO	OLV 2	ANT BL 2
---------------------	----------	-------------



### Art. 7.4280

Battente Mare 125x110 mm con perno passante.  
Mare door knocker ø 125x110 mm with through screw.

FINITURA IMBALLO	OLV 2	ANT BL 2
---------------------	----------	-------------

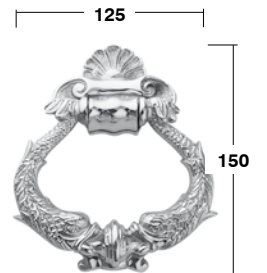

### Art. 7.4010

Battente Barocco con perno passante.  
Barocco door knocker with through screw.

	int. 120 mm	int. 150 mm
FINITURA IMBALLO	OLV 2	OLV 2

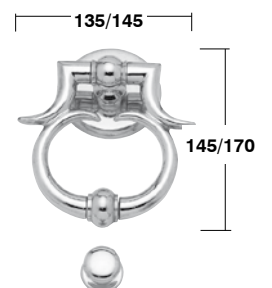



### Art. 7.4160

Battente Impero 125x100 mm con perno passante.  
Impero door knocker 125x100 mm with through screw.

FINITURA	OL	ANT
IMBALLO	2	2



### Art. 7.4170

Battente Leone Big 270x150 mm con perno passante.  
Leone big door knocker 270x150 mm with through screw.

FINITURA	OL
IMBALLO	2



### Art. 7.4075

Battente Manina media 110x60 mm con perno passante.  
Manina door knocker 110x60 mm with through screw.

FINITURA	OL	ANT
IMBALLO	2	2





**Art. 7.4130**

Battente Cavallo 140x120 mm con perno passante.  
Cavallo door knocker 140x120 mm with through screw.

FINITURA  
IMBALLO

ANT  
2



**Art. 7.4140**

Battente Maya 160x95 mm con perno passante.  
Maya door knocker 160x95 mm with through screw.

FINITURA  
IMBALLO

ANT  
2

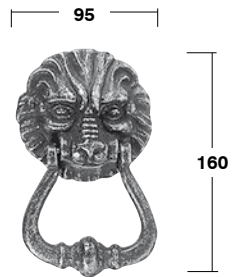

**Art. 7.4150**

Battente Medusa 165x120 mm con perno passante.  
Medusa door knocker 165x120 mm with through screw.

FINITURA  
IMBALLO

OL  
2

ANT  
2





### Art. 7.4027

Battente America 135 mm con perno passante  
America door knocker ø 135 mm with through screw.

FINITURA	OLV
IMBALLO	2



### Art. 7.4110

Maniglietta Anello con perno passante  
Anello door knocker with through screw.



90 mm

110 mm

130 mm

FINITURA	OLV	OLV	OLV
IMBALLO	2	2	2

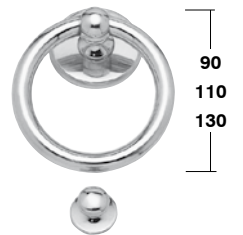

### Art. 7.4060

Battente Victorian con perno passante.  
Victorian door knocker with through screw.

int. 150 mm

int. 200 mm

FINITURA	OLV	OLV
IMBALLO	2	2

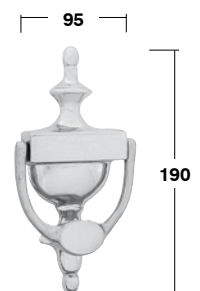



**Art. 7.4180**

Battente York ø 110 mm con perno passante.  
York door knocker ø 110 mm with through screw.

FINITURA IMBALLO	OLV 2
---------------------	----------



110



**Art. 7.4190**

Battente Porto ø 120 mm con perno passante.  
Porto door knocker ø 120 mm with through screw.

FINITURA IMBALLO	OLV 2	OGR 2	ARG ANT 2
---------------------	----------	----------	--------------



120



**Art. 7.4200**

Battente Ring ø 110 mm con perno passante.  
Ring door knocker ø 110 mm with through screw.

FINITURA IMBALLO	OLV 2	OGR 2	CRS 2
---------------------	----------	----------	----------



110



**Art. 3.2030**

Pomolo Ares ø 65 mm - base ø 56 mm con sottorosone/esagono.  
Knob Ares ø 65 mm - base ø 56 mm with fixed pivot.

FINITURA IMBALLO	OLV 2	OGR 2	CRS 2	PVD 2
---------------------	----------	----------	----------	----------



**Art. 3.2090**

Pomolo Zeus ø 74 mm - base ø 56 mm con sottorosone/esagono.  
Knob Zeus ø 74 mm - base ø 56 mm with fixed pivot.

FINITURA IMBALLO	OLV 2	OGR 2	CRS 2	PVD 2
---------------------	----------	----------	----------	----------



**Art. 3.0096.06**

Pomolo Diamante ø 60 mm - base ø 60 mm con perno passante.  
Knob Diamante ø 60 mm - base ø 60 mm with through screw.

FINITURA IMBALLO	OLV 6	OGR 6
---------------------	----------	----------



**Art. 3.0096.07**

Pomolo Diamante ø 70 mm - base ø 80 mm con perno passante.  
Knob Diamante ø 70 mm - base ø 80 mm with through screw.

FINITURA IMBALLO	OLV 6	OGR 6
---------------------	----------	----------



**Art. 3.0096.08**

Pomolo Diamante ø 80 mm - base ø 80 mm con perno passante.  
Knob Diamante ø 80 mm - base ø 80 mm with through screw.

FINITURA IMBALLO	OLV 2	OGR 2
---------------------	----------	----------





### Art. 3.0109.07

Pomolo Classic  $\varnothing$  70 mm - base  $\varnothing$  80 mm con perno passante.  
Knob Classic  $\varnothing$  70 mm - base  $\varnothing$  80 mm with through screw.

FINITURA IMBALLO	OLV 6	OGR 6	CRS 6
---------------------	----------	----------	----------

$\varnothing$  70



$\varnothing$  80

### Art. 3.0109.17

Pomolo Classic  $\varnothing$  70 mm - base  $\varnothing$  80 mm con sottorosone.  
Knob Classic  $\varnothing$  70 mm - base  $\varnothing$  80 mm with fixed pivot.

FINITURA IMBALLO	OLV 6	OGR 6	CRS 6
---------------------	----------	----------	----------



### Art. 3.0033

Pomolo Ringo  $\varnothing$  60 mm - base  $\varnothing$  45 mm con perno passante.  
Knob Ringo  $\varnothing$  60 mm - base  $\varnothing$  45 mm with through screw.

FINITURA IMBALLO	OLV 15	OGR 15
---------------------	-----------	-----------

$\varnothing$  60



$\varnothing$  45



### Art. 3.0116.06

Pomolo Sfera  $\varnothing$  60 mm - base  $\varnothing$  60 mm con perno passante.  
Knob Sfera  $\varnothing$  60 mm - base  $\varnothing$  60 mm with through screw.

FINITURA IMBALLO	OLV 6	OGR	CRS
---------------------	----------	-----	-----

$\varnothing$  60



$\varnothing$  60

### Art. 3.0116.07

Pomolo Sfera  $\varnothing$  70 mm - base  $\varnothing$  80 mm con perno passante.  
Knob Sfera  $\varnothing$  70 mm - base  $\varnothing$  80 mm with through screw.

FINITURA IMBALLO	OLV 6	OGR 6	CRS 6
---------------------	----------	----------	----------

$\varnothing$  70



$\varnothing$  80

### Art. 3.0116.08

Pomolo Sfera  $\varnothing$  80 mm - base  $\varnothing$  80 mm con perno passante.  
Knob Sfera  $\varnothing$  80 mm - base  $\varnothing$  80 mm with through screw.

FINITURA IMBALLO	OLV 2	OGR 2	CRS 2
---------------------	----------	----------	----------

$\varnothing$  80



$\varnothing$  80





### Art. 3.2000

Pomolo Gemini ø 43 mm con rosetta ø 45 mm ferro espansione 55 mm.  
 Knob Gemini ø 43 mm on ø 45 mm pressured fixed rose - expansion spindle 55 mm.

FINITURA IMBALLO	OLV 6	OGR 6	CRS 6
---------------------	----------	----------	----------

ø 43



ø 45



### Art. 3.2001

Pomolo Gemini ø 64 mm con rosetta ø 50 mm a pressione e sottorosone.  
 Knob Gemini ø 64 mm on ø 50 mm pressured fixed rose with fixed pivot.

FINITURA IMBALLO	OLV 2	OGR 2	CRS 2
---------------------	----------	----------	----------

ø 64



ø 50



### Art. 3.2020.17

Pomolo Lutus quadrato 50x50 mm con rosetta 45x45 mm con sottorosone.  
 Knob Lotus 50x50 mm on 45x45 mm square pressured fixed rose with fixed pivot.

FINITURA IMBALLO	OLV 2	OGR 2	CR 2	CRS 2
---------------------	----------	----------	---------	----------

50



45



### Art. 3.2025.16

Pomolo David quadro 60x60 mm con rosetta 50x50 mm con sottorosone.  
 Knob David 60x60 mm on 50x50 mm squared pressure fixed rose with fixed pivot.

FINITURA IMBALLO	OLV 2	OGR OP 2	CR 2	CRS 2
---------------------	----------	-------------	---------	----------

60



50





### Art. 3.2250.06

Pomolo Margherita ø 60 mm - base ø 60 mm con perno passante.  
Knob Margherita ø 60 mm - base ø 60 mm with through screw.

FINITURA IMBALLO	OLV 6	OGR 6
---------------------	----------	----------



### Art. 3.2250.07

Pomolo Margherita ø 70 mm - base ø 80 mm con perno passante.  
Knob Margherita ø 70 mm - base ø 80 mm with through screw.

FINITURA IMBALLO	OLV 6	OGR 6
---------------------	----------	----------



### Art. 3.2250.08

Pomolo Margherita ø 80 mm - base ø 80 mm con perno passante.  
Knob Margherita ø 80 mm - base ø 80 mm with through screw.

FINITURA IMBALLO	OLV 4	OGR 4
---------------------	----------	----------



### Art. 3.2180.07

Pomolo Blindo ø 70 mm - base ø 70 mm con perno passante.  
Knob Blindo ø 70 mm - base ø 70 mm with through screw.

FINITURA IMBALLO	OLV 6	OGR 6
---------------------	----------	----------



### Art. 3.2180.17

Pomolo Blindo ø 70 mm - base ø 70 mm con sottorosone.  
Knob Blindo ø 70 mm - base ø 70 mm with fixed pivot.

FINITURA IMBALLO	OLV 6	OGR 6
---------------------	----------	----------

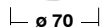

### Art. 3.6500

Pomolo Triangolo fisso con sottorosone rosetta ø 50 mm a pressione.  
Knob Triangolo ø 50 mm pressured fixed rose with fixed pivot.

FINITURA IMBALLO	OLV 4	SAT 4	CRS 4
---------------------	----------	----------	----------





### Art. 3.2130

Pomolo Spagna ø 72 mm - base ø 84 mm con perno passante.  
 Knob Spagna ø 72 mm - base ø 84 mm with fixed pivot.



FINITURA IMBALLO	OLV 2	OGR 2	CR 2
---------------------	----------	----------	---------



### Art. 3.2170.07

Pomolo Elite ø 70 mm - base ø 70 mm con perno passante.  
 Knob Elite ø 70 mm - base ø 70 mm with through screw.

FINITURA IMBALLO	OLV 6	OGR 6	CRS 6
---------------------	----------	----------	----------



### Art. 3.2170.17

Pomolo Elite ø 70 mm - base ø 70 mm con sottorosone.  
 Knob Elite ø 70 mm - base ø 70 mm with fixed pivot.

FINITURA IMBALLO	OLV 6	OGR 6	CRS 6
---------------------	----------	----------	----------



### Art. 3.2290

Pomolo Leo con rosetta ø 50 mm ad avvitare con ferro nyples.  
 Knob Leo on ø 50 mm screwed rose with nyples spindle.

FINITURA IMBALLO	OLV 2	OGR 2	CRS 2
---------------------	----------	----------	----------





**Art. 3.2260**

Pomolo Ottagonale ø 85 mm - base ø 85 mm con perno passante o sottorosone.  
 Knob Ottagonale ø 85 mm - base ø 85 mm with through screw or fixed pivot.

FINITURA IMBALLO	OLV 2	ANT 2
---------------------	----------	----------



**Art. 3.2140**

Pomolo Giglio ø 70 mm - base ø 70 mm con perno passante.  
 Knob Giglio ø 70 mm - base ø 70 mm with through screw.

FINITURA IMBALLO	OF 6
---------------------	---------



**Art. 3.2150**

Pomolo Luna ø 70 mm - base ø 70 mm con perno passante.  
 Knob Luna ø 70 mm - base ø 70 mm with through screw.

FINITURA IMBALLO	OF 6
---------------------	---------





**Art. 3.2045**

Pomolo Denver  $\varnothing$  70 mm con rosetts  $\varnothing$  50 mm a pressione e sottorosone.  
Denver Knob  $\varnothing$  70 mm on  $\varnothing$  50 mm pressured fixed rose with fixed pivot.

FINITURA	CRS
IMBALLO	2

$\varnothing$  70



$\varnothing$  50

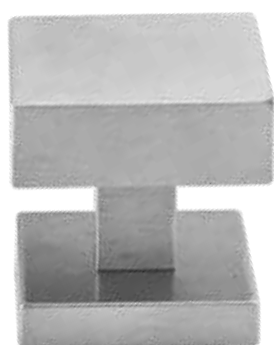

**Art. 3.2040**

Pomolo Athos 50x50 mm con rosetts 50x50 mm a pressione e sottorosone.  
Athos Knob 50x50 mm on 50x50 mm pressured fixed rose with fixed pivot.

FINITURA	CRS
IMBALLO	2

50

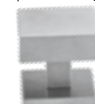

50



**Art. 3.2041**

Pomolo Aramis 50x50 mm con rosetts 50x50 mm a pressione e sottorosone - decentrato.  
Aramis Knob 50x50 mm on 50x50 mm pressured fixed rose with fixed pivot - off-set.

FINITURA	CRS
IMBALLO	2

50



50



**Art. 3.2410**

Pomolo Sfera ø 50 mm con rosetta ø 50 mm a pressione con sottorose.  
Sfera knob ø 50 mm on ø 50 mm pressured fixed rose with fixed pivot.

FINITURA	INOX
IMBALLO	2



**Art. 3.1060.15**

Pomolo Kubik quadro 50x50 mm con rosetta 50x50 mm con sottorose.  
Knob Kubik 50x50 mm on 50x50 mm square rose with fixed pivot.

FINITURA	INOX
IMBALLO	2



**Art. 3.2110**

Pomolo ottagonale ø 65 mm.  
Octagonal knob ø 65 mm.

FINITURA	FERRO NR
IMBALLO	2

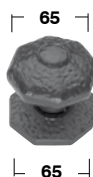

**Art. 3.2120**

Pomolo Denz ø 65 mm.  
Knob Denz ø 65 mm.

FINITURA	FERRO NR
IMBALLO	2





**Art. 3.6400**

Pomolo Thea fisso ø 70 mm - rosetta ø 50 mm a pressione fisso con sottorosone.  
Knob Thea ø 70 mm - ø 50 mm pressured fixed rose with fixed pivot.

FINITURA IMBALLO	ALL. BR 10	ALL. ARG 10
---------------------	---------------	----------------



**Art. 3.6450**

Pomolo Omega fisso ø 60 mm - rosetta ø 50 mm a pressione fisso con sottorosone.  
Knob Omega ø 60 mm - ø 50 mm pressured fixed rose with fixed pivot.

FINITURA IMBALLO	ALL. BR 10	ALL. ARG 10
---------------------	---------------	----------------



**Art. 3.6500**

Pomolo Triangolo fisso con sottorosone rosetta ø 50 mm a pressione.  
Knob Triangolo ø 50 mm pressured fixed rose with fixed pivot.

FINITURA IMBALLO	ALL. BR 10	ALL. ARG 10
---------------------	---------------	----------------



**Art. 3.2100**

Pomolo fisso ø 75 mm perno passante.  
Fixed knob ø 75 mm with through screw.

FINITURA IMBALLO	BN 12	NR 12
---------------------	----------	----------





**Art. PO 3.2074**

Coppia pomolo David 60x60 mm con rosetta e bocchetta quadra 50x50 mm a pressione.

Pair knob David 60x60 mm on 50x50 mm square pressured fixed rose and escutcheon.

FINITURA IMBALLO	OLV 1	OGR OP 1	CR 1	CRS 1
---------------------	----------	-------------	---------	----------



**Art. PO 2.2576**

Coppia pomolo Lotus 50x50 mm con rosetta e bocchetta quadra 45x45 mm a pressione.

Pair knob Lotus 50x50 mm on 45x45 mm square pressured fixed rose and escutcheon.

FINITURA IMBALLO	OLV 1	OGR OP 1	CR 1	CRS 1
---------------------	----------	-------------	---------	----------





### Art. 1.9210

Coppia pomolo Nettuno ø 60 mm con rosetta senza bocchetta.  
Pair knob Nettuno ø 60 mm on rose w/out escutcheon.

FINITURA IMBALLO	OLV 1
---------------------	----------



### Art. 1.1092

Coppia pomolo Victorian con rosetta e bocchetta con viti in vista senza molla.  
Pair knob Victorian on artistic rose and escutcheon w/out spring.

FINITURA IMBALLO	OLV 1	OGR 1	CRS 1
---------------------	----------	----------	----------



### Art. 1.1095

Coppia pomolo Victorian con rosetta e bocchetta Lux ø 45 mm ad avvitare.  
Pair knob Victorian on ø 45 mm screwed rose and escutcheon Lux.

FINITURA IMBALLO	OLV 1	OGR 1	CRS 1
---------------------	----------	----------	----------



### Art. 1.9116

Coppia pomolo Sfera ø 60 mm con rosetta senza bocchetta.  
Pair knob Sfera ø 60 mm on rose w/out escutcheon.

FINITURA IMBALLO	OLV 1
---------------------	----------





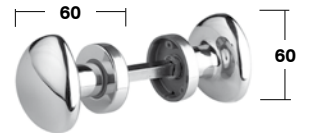

### Art. 1.9130

Guarnitura Triangolo **ottone** rosetta e bocchetta  $\varnothing$  45 mm a pressione.  
 Door handle Triangolo on  $\varnothing$  45 mm pressured fixed rose and escutcheon.

FINITURA IMBALLO	OLV 1	SAT 1	CRS 1
---------------------	----------	----------	----------

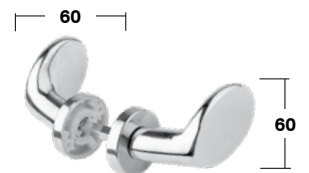

### Art. MA 3.1458

Guarnitura Viola rosetta staccata e bocchetta  $\varnothing$  50 mm a pressione.  
 Door handle Viola on  $\varnothing$  50 mm pressured unmounted rose and escutcheon.

FINITURA IMBALLO	OLV 1	OGR 1	CRS 1
---------------------	----------	----------	----------



### Art. 1.4660

Coppia pomolo Urano decentrato con rosetta e bocchetta ø 50 mm ad avvitare.  
 Pair knob Urano off-set on ø 50 mm screwed rose and escutcheon.

FINITURA IMBALLO	OLV 1	OGR 1
---------------------	----------	----------

## LINEA ALLUMINIO

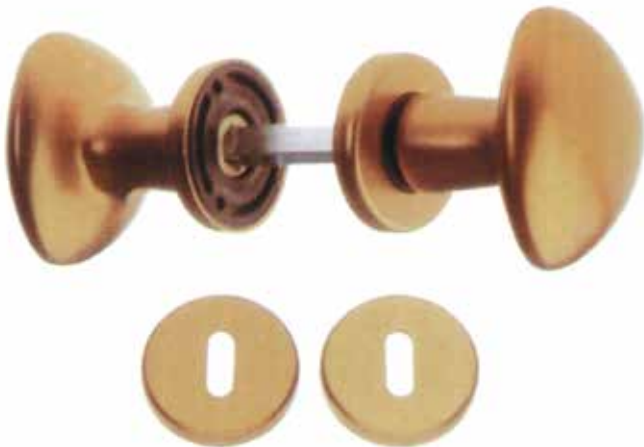

### Art. 1.9130

Guarnitura Triangolo rosetta e bocchetta ø 50 mm a pressione.  
 Door handle Triangolo on ø 50 mm pressured fixed rose and escutcheon.

FINITURA IMBALLO	ALL. BR 1	ALL. ARG 1
---------------------	--------------	---------------



### Art. 1.9140

Guarnitura Uovo rosetta e bocchetta ø 50 mm a pressione.  
 Door handle Uovo on ø 50 mm pressured fixed rose and escutcheon.

FINITURA IMBALLO	ALL. BR 1	ALL. ARG 1
---------------------	--------------	---------------

**Art. 1.3972**

Coppia pomolo tondo con rosetta e bocchetta con viti in vista senza molla in porcellana bianca.  
Pair round knob on artistic rose and escutcheon w/out spring - white porcelain.



FINITURA IMBALLO	PBN/OLV 1	PBN/ANT BL 1
---------------------	--------------	-----------------

∅ 60



∅ 45

**Art. 1.3975**

Coppia pomolo tondo con rosetta e bocchetta Lux ad avvitare in porcellana bianca.  
Pair round knob on ø 45 mm screwed rose and escutcheon Lux - white porcelain.



FINITURA IMBALLO	PBN/OLV 1	PBN/ANT BL 1
---------------------	--------------	-----------------

**Art. 1.3982**

Coppia pomolo ovale con rosetta e bocchetta con viti in vista senza molla in porcellana bianca.  
Pair oval knob on artistic rose and escutcheon w/out spring - white porcelain.



FINITURA IMBALLO	PBN/OLV 1	PBN/ANT BL 1
---------------------	--------------	-----------------

**Art. 1.3985**

Coppia pomolo ovale con rosetta e bocchetta Lux ad avvitare in porcellana bianca.  
Pair oval knob on ø 45 mm screwed rose and escutcheon Lux - white porcelain.



FINITURA IMBALLO	PBN/OLV 1	PBN/ANT BL 1
---------------------	--------------	-----------------



**Art. 1.6172**

Coppia pomolo tondo con rosetta e bocchetta con viti in vista senza molla in porcellana champagne.  
Pair round knob on artistic rose and escutcheon w/out spring - champagne porcelain.



FINITURA IMBALLO	PCH/OLV 1	PCH/ANT BL 1
---------------------	--------------	-----------------

∅ 60



∅ 45

**Art. 1.6175**

Coppia pomolo tondo con rosetta e bocchetta Lux ad avvitare in porcellana champagne.  
Pair round knob on ø 45 mm screwed rose and escutcheon Lux - champagne porcelain.



FINITURA IMBALLO	PCH/OLV 1	PCH/ANT.BL 1
---------------------	--------------	-----------------

**Art. 1.6182**

Coppia pomolo ovale con rosetta e bocchetta con viti in vista senza molla in porcellana champagne.  
Pair oval knob on artistic rose and escutcheon w/out spring - champagne porcelain.



FINITURA IMBALLO	PCH/OLV 1	PCH/ANT.BL 1
---------------------	--------------	-----------------

**Art. 1.6185**

Coppia pomolo ovale con rosetta e bocchetta Lux ad avvitare in porcellana champagne.  
Pair oval knob on ø 45 mm screwed rose and escutcheon Lux - champagne porcelain.



FINITURA IMBALLO	PCH/OLV 1	PCH/ANT.BL 1
---------------------	--------------	-----------------

### Art. 1.3072

Coppia pomolo tondo Alba con rosetta e bocchetta con viti in vista senza molla in porcellana bianca decorata.  
Pair knob Alba on artistic rose and escutcheon w/out spring - decorated porcelain.



FINITURA IMBALLO	PBN C.FIORE/OLV 1	PBN C.FIORE/ANT BL 1
---------------------	----------------------	-------------------------

∅ 60



∅ 45

### Art. 1.3075

Coppia pomolo tondo Alba con rosetta e bocchetta Lux ad avvitare in porcellana bianca decorata.  
Pair knob Alba on ø 45 mm screwed rose and escutcheon Lux - decorated porcelain.

FINITURA IMBALLO	PBN C.FIORE/OLV 1	PBN C.FIORE/ANT BL 1
---------------------	----------------------	-------------------------

### Art. 1.3082

Coppia pomolo ovale Alba con rosetta e bocchetta con viti in vista senza molla in porcellana bianca decorata.  
Pair oval knob Alba on artistic rose and escutcheon w/out spring - decorated porcelain.



FINITURA IMBALLO	PBN C.FIORE/OLV 1	PBN C.FIORE/ANT BL 1
---------------------	----------------------	-------------------------

### Art. 1.3085

Coppia pomolo ovale Alba con rosetta e bocchetta Lux ad avvitare in porcellana bianca decorata.  
Pair oval knob Alba on ø 45 mm screwed rose and escutcheon Lux - decorated porcelain.

FINITURA IMBALLO	PBN C.FIORE/OLV 1	PBN C.FIORE/ANT BL 1
---------------------	----------------------	-------------------------

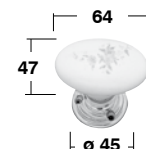

### Art. 1.5572

Coppia pomolo tondo con rosetta e bocchetta con viti in vista senza molla in porcellana bianca c/fiore blu.  
Pair round knob on artistic rose and escutcheon w/out spring - white porcelain with flower.



FINITURA IMBALLO	PBN-FIORE BLU / OLV 1	PBN-FIORE BLU / ANT BL 1
---------------------	--------------------------	-----------------------------

∅ 60



∅ 45

### Art. 1.5575

Coppia pomolo tondo con rosetta e bocchetta Lux ad avvitare in porcellana bianca c/fiore blu.  
Pair round knob on ø 45 mm screwed rose and escutcheon Lux - white porcelain with flower.

FINITURA IMBALLO	PBN-FIORE BLU / OLV 1	PBN-FIORE BLU / ANT BL 1
---------------------	--------------------------	-----------------------------

### Art. 1.5582

Coppia pomolo ovale con rosetta e bocchetta con viti in vista senza molla in porcellana bianca c/fiore blu.  
Pair oval knob on artistic rose and escutcheon w/out spring - white porcelain with flower.



FINITURA IMBALLO	PBN-FIORE BLU / OLV 1	PBN-FIORE BLU / ANT BL 1
---------------------	--------------------------	-----------------------------

### Art. 1.5585

Coppia pomolo ovale con rosetta e bocchetta Lux ad avvitare in porcellana bianca c/fiore blu.  
Pair oval knob on ø 45 mm screwed ros and escutcheon Lux - white porcelain with flower.

FINITURA IMBALLO	PBN-FIORE BLU / OLV 1	PBN-FIORE BLU / ANT BL 1
---------------------	--------------------------	-----------------------------

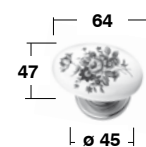

### Art. 1.6072

Coppia pomolo tondo Gemma con rosetta e bocchetta con viti in vista senza molla in porcellana champagne decorata.  
Pair knob Gemma on artistic rose and escutcheon w/out spring - decorated porcelain.



FINITURA IMBALLO	PCH C.FIORE/OLV 1	PCH C.FIORE/ANT BL 1
---------------------	----------------------	-------------------------

∅ 70



∅ 45

### Art. 1.6075

Coppia pomolo tondo Gemma con rosetta e bocchetta Lux ad avvitare in porcellana champagne decorata.  
Pair knob Gemma on ø 45 mm screwed rose and escutcheon Lux - decorated porcelain.

FINITURA IMBALLO	PCH C.FIORE/OLV 1	PCH C.FIORE/ANT BL 1
---------------------	----------------------	-------------------------

### Art. 1.6082

Coppia pomolo ovale Gemma con rosetta e bocchetta con viti in vista senza molla in porcellana champagne decorata.  
Pair oval knob Gemma on artistic rose and escutcheon w/out spring - decorated porcelain.



FINITURA IMBALLO	PCH C.FIORE/OLV 1	PCH C.FIORE/ANT BL 1
---------------------	----------------------	-------------------------

### Art. 1.6085

Coppia pomolo ovale Gemma con rosetta e bocchetta Lux ad avvitare in porcellana champagne decorata.  
Pair oval knob Gemma on ø 45 mm screwed rose and escutcheon Lux - decorated porcelain.

FINITURA IMBALLO	PCH C.FIORE/OLV 1	PCH C.FIORE/ANT BL 1
---------------------	----------------------	-------------------------

70



∅ 45

### Art. 1.6272

Coppia pomolo tondo Anna con rosetta e bocchetta con viti in vista senza molla in porcellana bianca decorata.  
Pair knob Anna on artistic rose and escutcheon w/out spring - decorated porcelain.



FINITURA IMBALLO	PBN C.FIORE/OLV 1	PBN C.FIORE/ANT BL 1
---------------------	----------------------	-------------------------

∅ 70



∅ 45

### Art. 1.6275

Coppia pomolo tondo Anna con rosetta e bocchetta Lux ad avvitare in porcellana bianca decorata.  
Pair knob Anna on ø 45 mm screwed rose and escutcheon Lux - decorated porcelain.

FINITURA IMBALLO	PBN C.FIORE/OLV 1	PBN C.FIORE/ANT BL 1
---------------------	----------------------	-------------------------

### Art. 1.6282

Coppia pomolo ovale Anna con rosetta e bocchetta con viti in vista senza molla in porcellana bianca decorata.  
Pair oval knob Anna on artistic rose and escutcheon w/out spring - decorated porcelain.



FINITURA IMBALLO	PBN C.FIORE/OLV 1	PBN C.FIORE/ANT BL 1
---------------------	----------------------	-------------------------

### Art. 1.6285

Coppia pomolo ovale Anna con rosetta e bocchetta Lux ad avvitare in porcellana bianca decorata.  
Pair oval knob Anna on ø 45 mm screwed rose and escutcheon Lux - decorated porcelain.

FINITURA IMBALLO	PBN C.FIORE/OLV 1	PBN C.FIORE/ANT BL 1
---------------------	----------------------	-------------------------

70



∅ 45



LINEA

# ACCESSORI MOBILI

SERIE POMOLINI  
PORCELLANA  
OTTONE  
ZAMA

SERIE  
PENDENTI PORCELLANA

SERIE MANIGLIETTE  
OTTONE  
FERRO  
PORCELLANA STILE  
PORCELLANA EXTRA  
INOX  
ZAMA

SERIE  
ANTICATO/RESTAURO

# Cottali



**Art. 2.9900**

Base ø18 mm per pomolini in porcellana.  
Base for porcelain cabinet knob ø 18 mm.

FINITURA IMBALLO	OL 50	NIK 50	ANT 50
---------------------	----------	-----------	-----------



**Art. 3.8000**

Pomolino tondo senza base.  
Cabinet round knob w/out base.

ø 26 - h. 24 mm      ø 30 - h. 25 mm

FINITURA IMBALLO	PBN 50	PBN 50
---------------------	-----------	-----------



**Art. 3.8001**

Pomolino tondo senza base.  
Cabinet round knob w/out base.

ø 30 - h. 25 mm

FINITURA IMBALLO	P. AZZURRO 50
---------------------	------------------



**Art. 3.8002**

Pomolino tondo senza base.  
Cabinet round knob w/out base.

ø 30 - h. 25 mm

FINITURA IMBALLO	P. VERDE 50
---------------------	----------------



**Art. 3.8003**

Pomolino tondo senza base.  
Cabinet round knob w/out base.

ø 26 - h. 24 mm      ø 30 - h. 25 mm

FINITURA IMBALLO	PCH 50	PCH 50
---------------------	-----------	-----------



**Art. 3.8006**

Pomolino tondo senza base.  
Cabinet round knob w/out base.

ø 26 - h. 24 mm      ø 30 - h. 25 mm

FINITURA IMBALLO	PBN F.MARRONE 50	PBN F.MARRONE 50
---------------------	---------------------	---------------------



### Art. 3.8007

Pomolino tondo senza base.  
Cabinet round knob w/out base.

ø 26 - h. 24 mm

ø 30 - h. 25 mm

FINITURA  
IMBALLO

PHC IBISCO  
50

PHC IBISCO  
50



### Art. 3.8008

Pomolino tondo senza base.  
Cabinet round knob w/out base.

ø 26 - h. 24 mm

ø 30 - h. 25 mm

FINITURA  
IMBALLO

PBN IBISCO  
50

PBN IBISCO  
50



### Art. 3.8010

Pomolino tondo senza base.  
Cabinet round knob w/out base.

ø 26 - h. 24 mm

ø 30 - h. 25 mm

FINITURA  
IMBALLO

PBN C/FIORE  
50

PBN C/FIORE  
50



### Art. 3.8011

Pomolino tondo senza base.  
Cabinet round knob w/out base.

ø 30 - h. 25 mm

FINITURA  
IMBALLO

PBN FIORE BLU  
50



### Art. 3.8013

Pomolino tondo senza base.  
Cabinet round knob w/out base.

ø 30 - h. 25 mm

FINITURA  
IMBALLO

PCH C/FIORE  
50



### Art. 3.8015

Pomolino tondo senza base.  
Cabinet round knob w/out base.

ø 30 - h. 25 mm

FINITURA  
IMBALLO

PBN F.ROSA  
50





### Art. 3.8020

Pomolino tondo senza base.  
Cabinet round knob w/out base.

ø 30 - h. 25 mm

FINITURA  
IMBALLO

PBN RIGA ORO  
50



### Art. 3.8023

Pomolino tondo senza base.  
Cabinet round knob w/out base.

ø 30 - h. 25 mm

FINITURA  
IMBALLO

PCH F.CAMPO  
50



### Art. 3.8025

Pomolino tondo senza base.  
Cabinet round knob w/out base.

ø 30 - h. 25 mm

FINITURA  
IMBALLO

PNR  
50



### Art. 3.8030

Pomolino ovale senza base.  
Cabinet oval knob w/out base.

33x24 - h. 26 mm

FINITURA  
IMBALLO

PBN  
50



### Art. 3.8031

Pomolino ovale senza base.  
Cabinet oval knob w/out base.

33x24 - h. 26 mm

FINITURA  
IMBALLO

P. AZZURRO  
50



### Art. 3.8032

Pomolino ovale senza base.  
Cabinet oval knob w/out base.

33x24 - h. 26 mm

FINITURA  
IMBALLO

P. VERDE  
50



### Art. 3.8033

Pomolino ovale senza base.  
Cabinet oval knob w/out base.

33x24 - h. 26 mm

FINITURA  
IMBALLO

PCH  
50



### Art. 3.8040

Pomolino ovale senza base.  
Cabinet oval knob w/out base.

33x24 - h. 26 mm

FINITURA  
IMBALLO

PBN C/FIORE  
50



### Art. 3.8041

Pomolino ovale senza base.  
Cabinet oval knob w/out base.

33x24 - h. 26 mm

FINITURA  
IMBALLO

PBN FIORE BLU  
50



### Art. 3.8043

Pomolino ovale senza base.  
Cabinet oval knob w/out base.

33x24 - h. 26 mm

FINITURA  
IMBALLO

PCH C/FIORE  
50



### Art. 3.8044

Pomolino ovale senza base.  
Cabinet oval knob w/out base.

33x24 - h. 26 mm

FINITURA  
IMBALLO

PBN IBISCO  
50



### Art. 3.8046

Pomolino ovale senza base.  
Cabinet oval knob w/out base.

33x24 - h. 26 mm

FINITURA  
IMBALLO

PBN MIOSOTIS  
50



### Art. 3.8047

Pomolino ovale senza base.  
Cabinet oval knob w/out base.

33x24 - h. 26 mm

FINITURA  
IMBALLO

PBN C/FIORE  
50



### Art. 3.8048

Pomolino ovale senza base.  
Cabinet oval knob w/out base.

33x24 - h. 26 mm

FINITURA  
IMBALLO

PCH IBISCO  
50



### Art. 3.8049

Pomolino ovale senza base.  
Cabinet oval knob w/out base.

33x24 - h. 26 mm

FINITURA  
IMBALLO

PBN F.MARRONE  
50



### Art. 3.8070

Pomolino tondo senza base.  
Cabinet round knob w/out base.

ø 30 - h. 25 mm

FINITURA  
IMBALLO

PBN FRUTTA  
50



### Art. 3.8071

Pomolino tondo senza base.  
Cabinet round knob w/out base.

ø 30 - h. 25 mm

FINITURA  
IMBALLO

PBN LIMONI  
50



### Art. 3.8072

Pomolino tondo senza base.  
Cabinet round knob w/out base.

ø 30 - h. 25 mm

FINITURA  
IMBALLO

PBN PERE  
50



### Art. 3.8073

Pomolino tondo senza base.  
Cabinet round knob w/out base.

ø 30 - h. 25 mm

FINITURA  
IMBALLO

PBN MELE  
50



### Art. 3.8074

Pomolino tondo senza base.  
Cabinet round knob w/out base.

ø 30 - h. 25 mm

FINITURA  
IMBALLO

PBN UVA  
50



### Art. 3.8075

Pomolino tondo senza base.  
Cabinet round knob w/out base.

ø 30 - h. 25 mm

FINITURA  
IMBALLO

PBN BOSCO  
50



### Art. 3.8076

Pomolino tondo senza base.  
Cabinet round knob w/out base.

ø 30 - h. 25 mm

FINITURA  
IMBALLO

PCH MISTO  
50



### Art. 3.8078

Pomolino tondo senza base.  
Cabinet round knob w/out base.

ø 30 - h. 25 mm

FINITURA  
IMBALLO

PCH MELA VERDE  
50



### Art. 3.8083

Pomolino tondo senza base.  
Cabinet round knob w/out base.

ø 26 - h. 24 mm

ø 30 - h. 25 mm

FINITURA  
IMBALLO

PCH CRACKLÈ  
50

PCH CRACKLÈ  
50



### Art. 3.8120

Pomolino Zucca.  
Cabinet knob Zucca.

ø 28 - h. 27 mm

ø 33 - h. 32 mm

FINITURA  
IMBALLO

PBN/OLV  
50

PBN/OLV  
50



**Art. 3.8197**

Pomolino ad anello ø 32 mm.  
Ring cabinet knob ø 32 mm.

FINITURA IMBALLO	OLV 25	BR 25	CR 25
---------------------	-----------	----------	----------



**Art. 3.8540**

Pomolino scalinato.  
Stepped cabinet knob.

ø 30 - h. 25 mm

FINITURA IMBALLO	OLV 25
---------------------	-----------



**Art. 3.8560**

Pomolino Margherita.  
Cabinet knob Margherita.

ø 30 - h. 29 mm

FINITURA IMBALLO	OLV 25
---------------------	-----------



**Art. 3.8710**

Pomolino.  
Brass cabinet knob.

	ø 15 mm	ø 20 mm	ø 25 mm	ø 30 mm	ø 35 mm
FINITURA IMBALLO	OLV 50	OLV 50	OLV 30	OLV 30	OLV 20
FINITURA IMBALLO	CRS 50	CRS 50	CRS 30	CRS 30	CRS 20



### Art. 3.8715

Pomolino.  
Brass cabinet knob.

	ø 20 mm	ø 25 mm	ø 30 mm	ø 35 mm
FINITURA IMBALLO	OLV 50	OLV 30	OLV 30	OLV 30
FINITURA IMBALLO	CRS 50	CRS 30	CRS 30	CRS 30



### Art. 3.8720

Pomolino.  
Brass cabinet knob.

	ø 17 mm	ø 20 mm	ø 25 mm	ø 32 mm
FINITURA IMBALLO	OLV 50	OLV 50	OLV 50	OLV 30



### Art. 3.8725

Pomolino.  
Brass cabinet knob.

	ø 17 mm	ø 20 mm	ø 25 mm	ø 32 mm
FINITURA IMBALLO	OLV 50	OLV 50	OLV 50	OLV 30



### Art. 3.8730

Pomolino.  
Brass cabinet knob.

	ø 20 mm	ø 25 mm	ø 30 mm	ø 35 mm
FINITURA IMBALLO	OLV 50	OLV 30	OLV 30	OLV 30



### Art. 3.8733

Pomolino.  
Brass cabinet knob.

	ø 25 mm	ø 30 mm	ø 35 mm
FINITURA IMBALLO	OLV 30	OLV 30	OLV 30



### Art. 3.8745

Pomolino.  
Brass cabinet knob.

ø 12 mm

ø 12 mm

FINITURA IMBALLO	OLV 50	CRS 50
---------------------	-----------	-----------



### Art. 3.8750

Pomolino.  
Brass cabinet knob.

ø 15 mm

ø 15 mm

FINITURA IMBALLO	OLV 50	CRS 50
---------------------	-----------	-----------



### Art. 3.8760

Pomolino.  
Brass cabinet knob.

ø 24 mm

ø 24 mm

FINITURA IMBALLO	OLV 50	CRS 50
---------------------	-----------	-----------



### Art. 3.8778

Pomolino.  
Brass cabinet knob.

ø 16 mm

ø 20 mm

ø 25 mm

ø 30 mm

FINITURA IMBALLO	OLV 50	OLV 50	OLV 50	OLV 30
---------------------	-----------	-----------	-----------	-----------



### Art. 3.8780

Pomolino.  
Brass cabinet knob.

ø 25 mm

ø 30 mm

FINITURA IMBALLO	OLV 50	OLV 50
---------------------	-----------	-----------



**Art. 3.8810**

Pomolino rigato.  
Striped cabinet knob.

ø 16 mm

ø 16 mm

FINITURA  
IMBALLO

Z. OTT  
25

Z. CR  
25



**Art. 3.8590**

Pomolino piatto.  
Flat cabinet knob.

ø 17 mm

ø 17 mm

ø 22 mm

ø 22 mm

FINITURA  
IMBALLO

Z. CR  
25

Z. CRS  
25

Z. CR  
25

Z. CRS  
25



**Art. 3.8570**

Pomolino.  
Cabinet knob.

ø 17 mm

ø 17 mm

FINITURA  
IMBALLO

Z. CR  
25

Z. CRS  
25



**Art. 3.8710 Z**

Pomolino.  
Cabinet knob.

ø 25 mm

ø 25 mm

FINITURA  
IMBALLO

Z. CR  
25

Z. CRS  
25



**Art. 3.8790**

Pomolino.  
Cabinet knob.

ø 24 mm

ø 24 mm

ø 29 mm

ø 29 mm

FINITURA  
IMBALLO

Z. CR  
25

Z. CRS  
25

Z. CR  
25

Z. CRS  
25





### Art. 3.8830

Pomolino 800.  
Cabinet knob 800.

	ø 25 mm	ø 25 mm	ø 25 mm
FINITURA IMBALLO	Z. ANT 25	Z. ORO ANT 25	Z. ARG ANT 25
	ø 30 mm	ø 30 mm	ø 30 mm
FINITURA IMBALLO	Z. ANT 25	Z. ORO ANT 25	Z. ARG ANT 25



### Art. 3.8765

Pomolino.  
Cabinet knob.

	ø 25 mm	ø 30 mm
FINITURA IMBALLO	Z. ANT 25	Z. ANT 25



### Art. 3.8880

Pomolino.  
Cabinet knob.

	ø 25 mm
FINITURA IMBALLO	Z. ANT 25



### Art. 3.8610

Pomolino.  
Cabinet knob.

	ø 30 mm
FINITURA IMBALLO	Z. ANT 25



### Art. 3.8655

Pomolino.  
Cabinet knob.

	ø 24 mm	ø 30 mm
FINITURA IMBALLO	Z. ANT 25	Z. ANT 25



### Art. 6.6133

Pomolino anello.  
Ring cabinet knob.

	ø 39 mm
FINITURA IMBALLO	Z. ANT 25



### Art. 3.8630

Pomolino.  
Cabinet knob.

	ø 24 mm	ø 29 mm
FINITURA IMBALLO	Z. ANT 25	Z. ANT 25

# SERIE PENDENTI PORCELLANA



## Art. 3.8190

Pendente snodato anticato 60x23 mm.  
Furniture handle 60x23 mm.

FINITURA IMBALLO	PBN 25
---------------------	-----------



## Art. 3.8194

Pendente anticato snodato 60x23 mm.  
Furniture handle 60x23 mm.

FINITURA IMBALLO	OLV 25	ANT 25
---------------------	-----------	-----------



## Art. 3.8191

Pendente snodato anticato 60x23 mm.  
Furniture handle 60x23 mm.

FINITURA IMBALLO	PCH IBISCO 25
---------------------	------------------



## Art. 3.8195

Pendente snodato anticato 60x23 mm.  
Furniture handle 60x23 mm.

FINITURA IMBALLO	PBN C/FIORE 25
---------------------	-------------------



## Art. 3.8192

Pendente snodato anticato 60x23 mm.  
Furniture handle 60x23 mm.

FINITURA IMBALLO	PBN F.BLU 25
---------------------	-----------------



## Art. 3.8196

Pendente snodato anticato 60x23 mm.  
Furniture handle 60x23 mm.

FINITURA IMBALLO	PBN F.MARRONE 25
---------------------	---------------------



## Art. 3.8193

Pendente snodato anticato 60x23 mm.  
Furniture handle 60x23 mm.

FINITURA IMBALLO	PCH 25
---------------------	-----------



## Art. 3.8199

Pendente snodato anticato 60x23 mm.  
Furniture handle 60x23 mm.

FINITURA IMBALLO	PCH C/FIORE 25
---------------------	-------------------



**Art. 3.2510**

Maniglia per mobili.  
Furniture handle.

	80 mm	100 mm	120 mm	140 mm
FINITURA	OL	OL	OL	OL
IMBALLO	50	50	50	50
FINITURA	CR	CR	CR	CR
IMBALLO	50	50	50	50



**Art. 3.2535**

Maniglia scanalata.  
Grooved furniture handle.

	140 mm	140 mm
FINITURA	OL	BR
IMBALLO	30	30



**Art. 3.2536**

Maniglia rigata.  
Striped furniture handle.

	140 mm	140 mm
FINITURA	OLV	BR
IMBALLO	30	30



**Art. 3.2590**

Maniglia Conchiglia rigata.  
Striped shell furniture handle.

	84x36 mm	84x36 mm
FINITURA	OLV	CRS
IMBALLO	25	25





### Art. 3.2595

Maniglia Conchiglia liscia.  
Smooth shell furniture handle.

84x36 mm

84x36 mm

FINITURA IMBALLO	OLV 25	CRS 25
---------------------	-----------	-----------



### Art. 3.2610

Maniglia Rialto.  
Rialto furniture handle.

64 mm

64 mm

64 mm

64 mm

FINITURA IMBALLO	OLV 25	CR 25	CRS 25	OGR 25
---------------------	-----------	----------	-----------	-----------

96 mm

96 mm

96 mm

96 mm

FINITURA IMBALLO	OLV 25	CR 25	CRS 25	OGR 25
---------------------	-----------	----------	-----------	-----------

### Art. 3.2640

Maniglia Ponte.  
Ponte furniture handle.

100 mm

125 mm

150 mm



FINITURA IMBALLO	OLV 25	OLV 25	OLV 25
---------------------	-----------	-----------	-----------

FINITURA IMBALLO	CR 25	CR 25	CR 25
---------------------	----------	----------	----------

FINITURA IMBALLO	CRS 25	CRS 25	CRS 25
---------------------	-----------	-----------	-----------

FINITURA IMBALLO	BR 25	BR 25	BR 25
---------------------	----------	----------	----------



### Art. 3.2695

Maniglia Geco con viti in vista.  
Geco furniture handle w/visible screws.

125 mm

125 mm

125 mm

FINITURA IMBALLO	OLV 25	CR 25	CRS 25
---------------------	-----------	----------	-----------



**Art. 3.2620**

Maniglia Firenze.  
Firenze handle.

115 mm

145 mm

220 mm

FINITURA IMBALLO	FERRO NR 12	FERRO NR 12	FERRO NR 12
---------------------	----------------	----------------	----------------



**Art. 3.2630**

Maniglia Rustica.  
Rustic handle.

150 mm

FINITURA IMBALLO	FERRO NR 24
---------------------	----------------



**Art. 3.2635**

Maniglia Basket.  
Basket handle.

150 mm



FINITURA IMBALLO	FERRO NR 24
---------------------	----------------



## Art. 3.3000

Maniglia Extra anticata.  
Furniture handle Extra.

int. 96 mm

FINITURA  
IMBALLO

PBN/Z. ANT  
25



## Art. 3.3001

Maniglia Extra anticata.  
Furniture handle Extra.

int. 96 mm

FINITURA  
IMBALLO

PBN MELA VERDE  
25



## Art. 3.3002

Maniglia Extra anticata.  
Furniture handle Extra.

int. 96 mm

FINITURA  
IMBALLO

PCH C/FIORE  
25



## Art. 3.3003

Maniglia Extra anticata.  
Furniture handle Extra.

int. 96 mm

FINITURA  
IMBALLO

PBN F.BLU  
25



## Art. 3.3006

Maniglia Extra anticata.  
Furniture handle Extra.

int. 96 mm

FINITURA  
IMBALLO

PBN F.MARRONE  
25



## Art. 3.3007

Maniglia Extra anticata.  
Furniture handle Extra.

int. 96 mm

FINITURA  
IMBALLO

PBN F.MIOSOTIS  
25



## Art. 3.3008

Maniglia Extra anticata.  
Furniture handle Extra.

int. 96 mm

FINITURA  
IMBALLO

PCH/ANT  
25

## LINEA PORCELLANA EXTRA



### Art. 3.2600

Maniglia Extra.  
Furniture handle Extra.

int. 74 mm

int. 74 mm

FINITURA  
IMBALLO

PBN/ANT  
25

PBN/CRS  
25



### Art. 3.2601

Maniglia Extra anticata.  
Furniture handle Extra.

int. 74 mm

FINITURA  
IMBALLO

PBN MELA VERDE  
25



### Art. 3.2602

Maniglia Extra anticata.  
Furniture handle Extra.

int. 74 mm

FINITURA  
IMBALLO

PCH C/FIORE  
25



### Art. 3.2603

Maniglia Extra anticata.  
Furniture handle Extra.

int. 74 mm

FINITURA  
IMBALLO

PBN F.BLU  
25



### Art. 3.2606

Maniglia Extra anticata.  
Furniture handle Extra.

int. 74 mm

FINITURA  
IMBALLO

PBN F.MARRONE  
25



### Art. 3.2607

Maniglia Extra anticata.  
Furniture handle Extra.

int. 74 mm

FINITURA  
IMBALLO

PBN F.MIOSOTIS  
25



### Art. 3.2608

Maniglia Extra anticata.  
Furniture handle Extra.

int. 74 mm

FINITURA  
IMBALLO

PCH/ANT  
25

## LINEA INOX



### Art. 3.3010

Maniglia Linea ø 12 mm.  
Linea handle ø 12 mm.

	128 mm	160 mm	224 mm	288 mm
FINITURA IMBALLO	INOX 12	INOX 12	INOX 12	INOX 12

## LINEA ZAMA



### Art. 3.2615

Maniglia Bastoncino.  
Bastoncino furniture handle.

	int. 64 mm	int. 96 mm	int.128 mm
FINITURA IMBALLO	Z.OTT 24	Z.OTT 24	Z.OTT 24
FINITURA IMBALLO	Z.CR 24	Z.CR 24	Z.CR 24
FINITURA IMBALLO	Z.CRS 24	Z.CRS 24	Z.CRS 24



### Art. 3.3055

Maniglia Rettangolare.  
Rettangular furniture handle.

	int. 96 mm	int. 128 mm
FINITURA IMBALLO	Z.CRS 24	Z.CRS 24





**Art. 6.6000**

Maniglia senza foro chiave 94x44 mm - int. 64 mm.  
 Furniture handle w/out hole 94x44 mm - int. 64 mm.

FINITURA  
 IMBALLO

ANT  
 25



**Art. 6.6001**

Maniglia con foro chiave 94x44 mm - int. 64 mm.  
 Furniture handle w/hole 94x44 mm - int. 64 mm.

FINITURA  
 IMBALLO

ANT  
 25



### Art. 6.5410

Maniglia senza foro chiave 96x46 mm.  
Furniture handle w/out hole 96x46 mm.



FINITURA  
IMBALLO

ANT  
25



### Art. 6.5411

Maniglia con foro chiave 96x46 mm.  
Furniture handle w/hole 96x46 mm.



FINITURA  
IMBALLO

ANT  
25



### Art. 6.6060

Maniglia senza foro chiave 34x96 mm.  
Furniture handle w/out hole 34x96 mm.



FINITURA  
IMBALLO

ANT  
25



### Art. 6.6061

Maniglia con foro chiave 34x96 mm.  
Furniture handle w/hole 34x96 mm.



FINITURA  
IMBALLO

ANT  
25



### Art. 6.5810

Maniglia ovale a incasso 78x25 mm - int. 64x22.  
Oval encased plate 78x25 mm - int. 64x22 mm.

FINITURA  
IMBALLO

ANT  
25



### Art. 6.5840

Maniglia portanome int. 55x23 mm.  
Furniture handle int. 55x23 mm.

FINITURA  
IMBALLO

ANT  
25



### Art. 6.5420

Maniglia 35x59 mm.  
Furniture handle 35x59 mm.

FINITURA  
IMBALLO

ANT  
25



### Art. 6.6070

Maniglia 34x48 mm.  
Furniture handle 34x48 mm.

FINITURA  
IMBALLO

ANT  
25



### Art. 6.6080

Maniglia 50x52 mm.  
Furniture handle 50x52 mm.

FINITURA  
IMBALLO

ANT  
25



### Art. 6.6090

Maniglia 34x55 mm.  
Furniture handle 34x55 mm.

FINITURA  
IMBALLO

ANT  
25



### Art. 6.5881

Maniglia 76x33 mm - int. 32 mm.  
Furniture handle 76x33 mm - int. 32 mm.

FINITURA IMBALLO	ANT 25
---------------------	-----------



### Art. 6.5860

Maniglia 96 mm.  
Furniture handle 96 mm.

### 6.5861

64 mm

FINITURA IMBALLO	ANT 25	ANT 25
---------------------	-----------	-----------



### Art. 6.5900

Maniglia 118x42 mm - int. 96 mm.  
Furniture handle 118x42 mm - int. 96 mm.

### 6.5901

82x32 mm - int. 64 mm

FINITURA IMBALLO	ANT 25	ANT 25
---------------------	-----------	-----------



### Art. 6.6010

Maniglia 85x34 mm.  
Furniture handle 85x34 mm.

FINITURA IMBALLO	ANT 25
---------------------	-----------



### Art. 6.5970

Maniglia 96 mm.  
Furniture handle 96 mm.

### 6.5971

64 mm

FINITURA IMBALLO	ANT 25	ANT 25
---------------------	-----------	-----------



### Art. 6.6131

Maniglia ø 37 mm.  
Furniture handle ø 37 mm.

FINITURA IMBALLO	ANT 25
---------------------	-----------



### Art. 6.6300

Bocchetta verticale 32x96 mm.  
Vertical escutcheon 32x96 mm.

FINITURA  
IMBALLO

ANT  
25



### Art. 6.6200

Bocchetta 30x50 mm.  
Escutcheon 30x50 mm.

FINITURA  
IMBALLO

ANT  
25



### Art. 6.6205

Bocchetta 34x46 mm.  
Escutcheon 34x46 mm.

FINITURA  
IMBALLO

ANT  
25



### Art. 6.6240

Bocchetta 15x98 mm.  
Escutcheon 15x98 mm.

FINITURA  
IMBALLO

ANT  
25



### Art. 6.6250

Bocchetta 18x36 mm.  
Escutcheon 18x36 mm.

FINITURA  
IMBALLO

ANT  
25



### Art. 6.6260

Bocchetta 24x46 mm.  
Escutcheon 24x46 mm.

FINITURA  
IMBALLO

ANT  
25



### Art. 6.6270

Bocchetta ø 32 mm.  
Escutcheon ø 32 mm.

FINITURA  
IMBALLO

ANT  
25



### Art. 6.6410

Chiave ø 6x32 mm.  
Brass key ø 6x32 mm.

FINITURA  
IMBALLO

ANT  
25



### Art. 6.6420

Chiave ø 6x40 mm.  
Brass key ø 6x40 mm.

**6.6421**  
ø 6x32 mm

**6.6422**  
mappa grande

FINITURA  
IMBALLO

ANT  
25

ANT  
25

ANT  
25



### Art. 6.6430

Chiave ø 6x43 mm.  
Brass key ø 6x43 mm.

**6.6431**  
ø 6x32 mm

FINITURA  
IMBALLO

ANT  
25

ANT  
25



### Art. 6.6440

Chiave ø 6x40 mm.  
Brass key ø 6x40 mm.



FINITURA  
IMBALLO

ANT  
25



### Art. 6.6470

Chiave ø 6x40 mm.  
Brass key ø 6x40 mm.

FINITURA  
IMBALLO

ANT  
25



### Art. 3.8625

Pomolino.  
Cabinet knob.

ø 20 mm      ø 25 mm      ø 30 mm

FINITURA IMBALLO	ANT 25	ANT 25	ANT 25
---------------------	-----------	-----------	-----------



### Art. 3.8635

Pomolino.  
Cabinet knob.

ø 23 mm      ø 27 mm      ø 32 mm

FINITURA IMBALLO	ANT 25	ANT 25	ANT 25
---------------------	-----------	-----------	-----------



### Art. 3.8640

Pomolino.  
Cabinet knob.

ø 24 mm      ø 29 mm      ø 34 mm

FINITURA IMBALLO	ANT 25	ANT 25	ANT 25
---------------------	-----------	-----------	-----------



### Art. 3.8645

Pomolino.  
Cabinet knob.

ø 20 mm      ø 25 mm

FINITURA IMBALLO	ANT 25	ANT 25
---------------------	-----------	-----------



### Art. 3.8615

Pomolino.  
Cabinet knob.

ø 20 mm      ø 27 mm      ø 32 mm

FINITURA IMBALLO	ANT 25	ANT 25	ANT 25
---------------------	-----------	-----------	-----------



### Art. 3.8665

Pomolino.  
Cabinet knob.

ø 25 mm      ø 30 mm

FINITURA IMBALLO	ANT 25	ANT 25
---------------------	-----------	-----------



A close-up photograph of a brass hinge mounted on a dark wood door. The hinge is made of polished brass and is secured with screws. The background is slightly blurred, showing the texture of the wood and a hint of a window or light source.

LINEA

# *MINUTERIE* *OTTONE*

SERIE

CITOFONI E CAMPANELLI

BUCALETTERE

PLACCHE PORTANOME

TARGHETTE

BASI PER NUMERI

NUMERI E LETTERE

CATENELLE DI SICUREZZA

CHIAVI

SCORRICINGHIA

COPRIAVVOLGIBILI

COPRINTERRUTTORI

CATENACCI

CHIAVISTELLI

LUCCHETTI E CHIUDIPIORTA

PARACOLPI E FERMAPORTA

BLOCCAPERSIANE

CERNIERE

PORTABITI E GANCI

SET PER TENDE

SUPPORTI PER CORRIMANO

REGGIMENSOLE

ACCESSORI VARI

Cottali





**Art. 7.2020**

Campanello Country.  
Country bell.

FINITURA IMBALLO	OLV 1	ANT 1
---------------------	----------	----------

**N.B. : IL PULSANTE È SEMPRE OTTONE LUCIDO**



**Art. 7.2010.01**

Pulsantiera 1 posto 120x140 mm.  
1 place button panel 120x140 mm.

FINITURA IMBALLO	OLV 1	ANT 1
---------------------	----------	----------



**Art. 7.2010.02**

Pulsantiera 2 posti 120x160 mm.  
2 place button panel 120x160 mm.

FINITURA IMBALLO	OLV 1	ANT 1
---------------------	----------	----------



### Art. 7.2050

Campanello Silvia con finestrella 140x72 mm - int. 96 mm.  
Silvia bell 140x72 mm with hole - int. 96 mm.

FINITURA IMBALLO	OLV 2	ANT 2
---------------------	----------	----------



### Art. 7.2051

Campanello Silvia senza finestra 140x72 mm - int. 96 mm.  
Silvia bell 140x72 mm w/out hole - int. 96 mm.

FINITURA IMBALLO	OLV 2	ANT 2
---------------------	----------	----------



### Art. 7.2053

Campanello Ibiza con finestrella 122x73 mm - int. 96 mm.  
Ibiza bell 122x73 mm with hole - int. 96 mm.

FINITURA IMBALLO	OLV 2	OGR 2	CR 2	CRS 2
---------------------	----------	----------	---------	----------



### Art. 7.2054

Campanello Ibiza senza finestrella 122x73 mm - int. 96 mm.  
Ibiza bell 122x73 mm w/out hole - int. 96 mm.

FINITURA IMBALLO	OLV 2	OGR 2	CR 2	CRS 2
---------------------	----------	----------	---------	----------



### Art. 7.2055

Campanello ovale con finestrella 132x72 mm - int. 96 mm.  
Oval bell 132x72 mm with hole - int. 96 mm.

FINITURA IMBALLO	OLV 2	ANT 2
---------------------	----------	----------



### Art. 7.2056

Campanello ovale senza finestrella 132x72 mm - int. 96 mm.  
Oval bell 132x72 mm w/out hole - int. 96 mm.

FINITURA IMBALLO	OLV 2	ANT 2
---------------------	----------	----------



### Art. 7.2025

Campanello Stile ø 65 mm.  
Stile bell ø 65 mm.

FINITURA IMBALLO	OGR OP 1
---------------------	-------------



### Art. 7.2090

Campanello Leoncino 72x70 mm.  
Leoncino bell 72x70 mm.

FINITURA IMBALLO	OLV 2	ANT 2
---------------------	----------	----------



### Art. 7.2060

Campanello Classic tondo concavo con bordo ø 75 mm.  
Classic bell with bord ø 75 mm.

FINITURA IMBALLO	OL 2
---------------------	---------



### Art. 7.2070

Campanello Venezia tondo concavo con bordo ø 58 mm.  
Venezia bell with bord ø 58 mm.

FINITURA IMBALLO	OLV 2
---------------------	----------



### Art. 7.2080

Pulsante per campanello ø 16x38 mm.  
Button for bell ø 16x38 mm.

FINITURA IMBALLO	OLV 25	BR 25	CR 25	CRS 25
---------------------	-----------	----------	----------	-----------



### Art. 7.2100

Campanello su rosetta Lux ø 45 mm.  
Bell on ø 45 mm Lux rose.

FINITURA IMBALLO	OLV 2	ANT 2	CR 2
---------------------	----------	----------	---------



### Art. 7.2130

Campanello rosetta ovale rigata 30x62 mm.  
Bell on striped oval rose 30x62 mm.

FINITURA IMBALLO	OLV 2
---------------------	----------

# SERIE BUCALLETTERE



## Art. 7.3170

Bucallettere 350X90 mm.  
Letterbox 350x90 mm.



FINITURA  
IMBALLO

FERRO NR  
1



## Art. 7.3160

Bucallettere 254X75 mm.  
Letterbox 254x75 mm.

FINITURA  
IMBALLO

OLV/SAT  
1

NR/SAT  
1



## Art. 7.3140

Bucallettere Victorian 254x75 mm.  
Victorian letterbox 254x75 mm.

FINITURA  
IMBALLO

OLV  
1

OGR  
1

CR  
1

CRS  
1



## Art. 7.3145

Bucallettere Gravity 254x75 mm.  
Gravity letterbox 254x75 mm.

FINITURA  
IMBALLO

OLV  
1

OGR  
1

CR  
1

CRS  
1

# SERIE PLACCHE PORTANOME



## Art. 7.0010

Placca portanome Capri ovale bombata, **pesante** 140x70 mm.  
Capri **heavy** oval name-plate 140x70 mm.

FINITURA  
IMBALLO

OLV  
2



## Art. 7.0020

Placca portanome Vesuvio ovale **leggero** 120x60 mm.  
Vesuvio **light** oval name-plate 120x60 mm.

**7.0021**  
**80x40 mm**

FINITURA  
IMBALLO

OLV  
10

OLV  
10



## Art. 7.0110

Placca portanome Todi 82x46 mm.  
Todi name-plate 82x46 mm.

FINITURA  
IMBALLO

OLV  
10



**Art. 00716**

Targhetta figura uomo 100x40 mm.  
Man figure plate 100x40 mm.

FINITURA  
IMBALLO

OLV  
12



**Art. 00717**

Targhetta figura donna 100x40 mm.  
Woman figure plate 100x40 mm.

FINITURA  
IMBALLO

OLV  
12



**Art. 00720**

Targhetta bagno 130x40 mm.  
Toilette plate 130x40 mm.

FINITURA  
IMBALLO

OLV  
10



**Art. 00730**

Targhetta bagno 100x50 mm.  
WC plate 100x50 mm.

FINITURA  
IMBALLO

OLV  
10

# SERIE BASI PER NUMERI

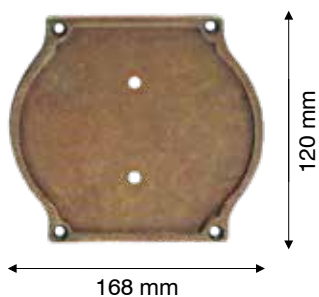

## Art. 9.1050.01

Base per 1 numero.  
Base for 1 number.

FINITURA IMBALLO	ANT 2
---------------------	----------

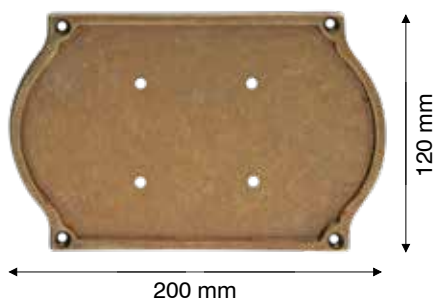

## Art. 9.1050.02

Base per 2 numeri.  
Base for 2 numbers.

FINITURA IMBALLO	ANT 2
---------------------	----------

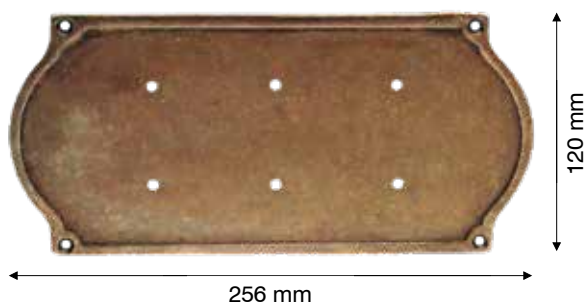

## Art. 9.1050.03

Base per 3 numeri.  
Base for 3 numbers.

FINITURA IMBALLO	ANT 2
---------------------	----------

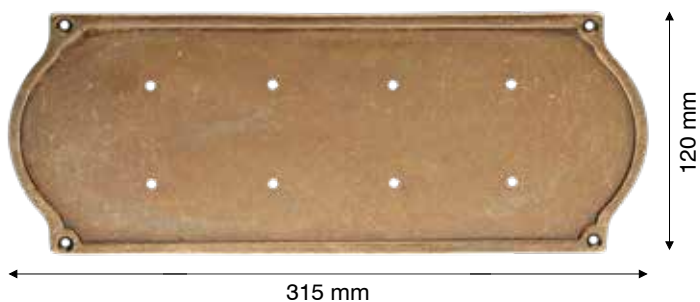

## Art. 9.1050.04

Base per 4 numeri.  
Base for 4 numbers.

FINITURA IMBALLO	ANT 2
---------------------	----------



## Art. 9.1060

Numero civico Lux 78x60 mm.  
Lux number 78x60 mm.

FINITURA IMBALLO	ANT/OLV 4
---------------------	--------------





**Art. 9.0910**

Lettere **alfabeto completo** 50 mm con pioli.  
Letters **complete alphabet** 50 mm w/pins.



FINITURA  
IMBALLO

OLV  
10



**Art. 9.0915**

Numero civico 50 mm con pioli.  
Number 50 mm w/pins.



FINITURA  
IMBALLO

OLV  
10



**Art. 9.0920**

Numero civico 125 mm con fori.  
Number 125 mm w/holes.

FINITURA  
IMBALLO

OLV  
10



**Art. 9.0930**

Numero civico 50 mm con fori.  
Number 50 mm w/holes.

FINITURA  
IMBALLO

OLV  
10



**Art. 9.0945**

Numero civico - 100 mm con chiodo filettato 5 ma e tassello.  
Number 100 mm w/5 ma threaded nail and anchor.

FINITURA  
IMBALLO

OLV  
10



### Art. 9.0960

Numero civico inglese 75 mm con fori.  
English number 75 mm w/holes.

FINITURA  
IMBALLO

OLV  
10



### Art. 9.0990

Numero civico gotico 120 mm.  
Gothic number 120 mm.

FINITURA  
IMBALLO

FUMÈ  
10



### Art. 9.0948

Lettere "A/B/C/D" 50 mm.  
Letters "A/B/C/D" 50 mm.

FINITURA  
IMBALLO

FERRO NR  
10



### Art. 9.0950

Numero civico con fori 75 mm.  
Number 75 mm w/holes.

FINITURA  
IMBALLO

FERRO NR  
10



**Art. 7.4080**

Catenella di sicurezza Napoli **leggera** 150 mm.  
Napoli safety chain 150 mm - **light**.

FINITURA IMBALLO	OL 50	BR 50
---------------------	----------	----------

**Art. 7.4081**

Catenella di sicurezza Napoli **pesante** 180 mm.  
Napoli safety chain 180 mm - **heavy**.

FINITURA IMBALLO	OL 50	BR 50
---------------------	----------	----------



**Art. 7.4090**

Catenella di sicurezza.  
Safety chain.

FINITURA IMBALLO	OTT 20	BR 20	NIK 20
---------------------	-----------	----------	-----------



**Art. 6.0090**

Gancio Roma.  
Roma hook.

FINITURA IMBALLO	OLV 12	BR 12
---------------------	-----------	----------

## SERIE CHIAVI



### Art. 2.2400

Chiave universale.  
Universal key.

FINITURA IMBALLO	OLV 12	CRS 12	ARG ANT 12
---------------------	-----------	-----------	---------------



### Art. 2.2480

Chiave maschio 100 mm con mappa 13x12 mm.  
Male key 100 mm - map 13x12 mm.

FINITURA IMBALLO	FERRO NR 12
---------------------	----------------

## SERIE SCORRICINGHIA



### Art. 4.2314

Scorricinghia Ovale 35x60 mm.  
Oval roller 35x60 mm.

FINITURA IMBALLO	OLV 10	BR 10	CRS 10	BN 10
---------------------	-----------	----------	-----------	----------



### Art. 4.2315

Scorricinghia Rettangolare 60x45 mm.  
Rectangular roller 60x45 mm.

FINITURA IMBALLO	OLV 10	BR 10	CRS 10	BN 10
---------------------	-----------	----------	-----------	----------



### Art. 4.2316

Scorricinghia Lusso 62x52 mm.  
Lusso roller 62x52 mm.

FINITURA IMBALLO	OLV 10	BR 10	CRS 10	BN 10
---------------------	-----------	----------	-----------	----------



**Art. 4.9510**

Copriavvolgibile Eko 240x53 mm.  
Eko roller blind cover 240x53 mm.

FINITURA IMBALLO	OLV 20	OGR 20	CRS 20	BN 20
---------------------	-----------	-----------	-----------	----------



**Art. 4.9530**

Copriavvolgibile Classic 278x56 mm.  
Classic roller blind cover 278x56 mm.

FINITURA IMBALLO	OLV 12	OGR 12	CRS 12	BN 12
---------------------	-----------	-----------	-----------	----------



### Art. 4.9540

Copriavvolgibile Flora 280x57 mm.  
Flora roller blind cover 280x57 mm.

FINITURA	BR
IMBALLO	12



### Art. 2.0030

Placca cieca 278x56 mm copriautomazione per tapparelle.  
Blind plate cover 278x56 mm.

FINITURA	OLV	OGR	CRS
IMBALLO	12	12	12

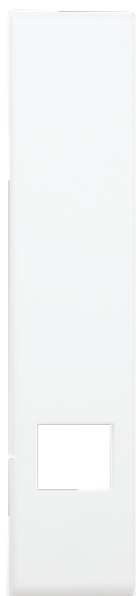

### Art. 4.9515

Copriavvolgibile Click 256x56 mm - plastica.  
Click roller 256x56 mm - plastic.

FINITURA	BN	NR
IMBALLO	20	20

# SERIE COPRINTERRUTTORI

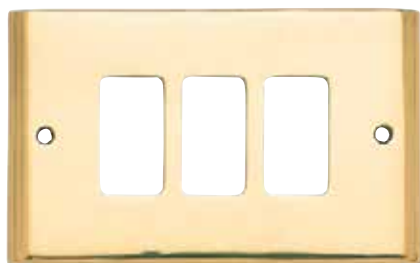

## Art. 8.2000

Coprinterruttore Ibiza 125x74 mm.  
Ibiza switch cover plate 125x74 mm.

	cieco	cieco	cieco
FINITURA IMBALLO	OLV 10	OGR 10	CRS 10
	<b>1-2-3</b>	<b>1-2-3</b>	<b>1-2-3</b>
FINITURA IMBALLO	OLV 10	OGR 10	CRS 10
	<b>4-5</b>	<b>4-5</b>	<b>4-5</b>
FINITURA IMBALLO	OLV 4	OGR 4	CRS 4

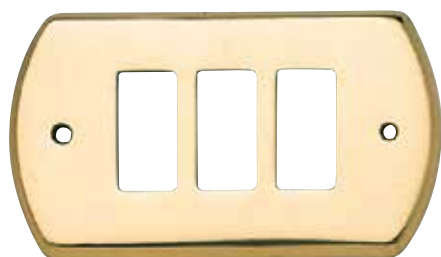

## Art. 8.2030

Coprinterruttore Classic 132x72 mm.  
Classic switch cover plate 132x72 mm.

	cieco	cieco	cieco
FINITURA IMBALLO	OLV 10	OGR 10	CRS 10
	<b>1-2-3</b>	<b>1-2-3</b>	<b>1-2-3</b>
FINITURA IMBALLO	OLV 10	OGR 10	CRS 10
	<b>4-5</b>	<b>4-5</b>	<b>4-5</b>
FINITURA IMBALLO	OLV 4	OGR 4	CRS 4



## Art. 8.2060

Coprinterruttore Venezia 145x73 mm.  
Venezia switch cover plate 145x73 mm.



	1-2-3	1-2-3
FINITURA IMBALLO	OLV 10	ANT 10

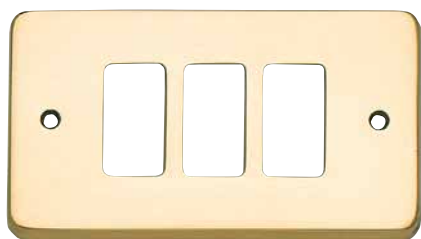

## Art. 8.2090

Coprinterruttore Praga 124x70 mm.  
Praga switch cover plate 124x70 mm.



	1-2-3	1-2-3	1-2-3
FINITURA IMBALLO	OLV 10	OGR 10	CRS 10



**Art. 5.4230**

Catenaccio orizzontale per spagnolette base 38x13 cm con incontro.  
Horizontal bolt base 38x13 cm w/strike.

200 mm

FINITURA  
IMBALLO

OTT. VERNICIATO NERO  
4





### Art. 5.4030

Catenaccio binario.  
Track bolt.

60 mm

FINITURA	OL
IMBALLO	20



### Art. 5.4050

Catenaccio sagomato leggero con incontro.  
Shaped bolt w/strike - light.

50 mm

60 mm

80 mm

FINITURA	OL	OL	OL
IMBALLO	24	24	24

100 mm

120 mm

FINITURA	OL	OL
IMBALLO	24	24

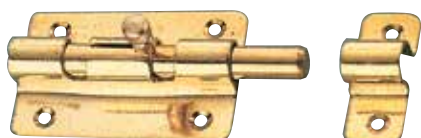

### Art. 5.4060

Catenaccio a cannone con incontro.  
Cannon bolt w/strike.

60 mm

80 mm

100 mm

120 mm

FINITURA	OL	OL	OL	OL
IMBALLO	24	24	24	24



### Art. 5.4066

Catenaccio a cannone - base tonda.  
Cannon bolt w/strike - round base.

80 mm

100 mm

FINITURA	OL	OL
IMBALLO	24	24



### Art. 5.4075

Catenaccio a cannone rigato con incontro.  
Striped cannon bolt w/strike.

	60x19 mm	75x19 mm	100x25 mm	150x38 mm
FINITURA IMBALLO	OLV 12	OLV 12	OLV 12	OLV 12
FINITURA IMBALLO	CR 12	CR 12	CR 12	CR 12



### Art. 5.4080

Catenaccio tondo con molla.  
Round bolt w/spring.

	60 mm	80 mm	100 mm	120 mm
FINITURA IMBALLO	OL 12	OL 12	OL 12	OL 12



### Art. 5.4100

Catenaccio orizzontale con incontro.  
Horizontal bolt w/strike.

	100 mm	150 mm
FINITURA IMBALLO	OLV 12	OLV 12



### Art. 5.4180

Catenaccio Rustico in ferro.  
Iron rustic bolt.

	150 mm	200 mm
FINITURA IMBALLO	NR 12	NR 12



### Art. 5.4300

Catenaccio tradizionale con incontro.  
Standard bolt w/strike.

	120 mm	150 mm	200 mm	250 mm	300 mm
FINITURA IMBALLO	OLV 6	OLV 6	OLV 6	OLV 6	OLV 6



### Art. 5.4250

Catenaccio Sigaro.  
Sigaro bolt w/strike.

	114x22 mm	152x22 mm	114x22 mm	152x22 mm
FINITURA IMBALLO	OLV 12	OLV 12	CR 12	CR 12



### Art. 5.4270

Catenaccio Flat con incontro.  
Flat bolt w/strike.

	50 mm	60 mm	80 mm	100 mm
FINITURA IMBALLO	OLV 12	OLV 12	OLV 12	OLV 12
FINITURA IMBALLO	CR 12	CR 12	CR 12	CR 12



### Art. 5.4200

Catenaccio sfaccettato con incontro.  
Bolt w/strike.

	50 mm	75 mm	100 mm	125 mm
FINITURA	OLV	OLV	OLV	OLV
IMBALLO	12	12	12	12

  

	150 mm	200 mm	300 mm	400 mm
FINITURA	OLV	OLV	OLV	OLV
IMBALLO	12	12	12	12



### Art. 5.4240

Catenaccio **verticale** America bivalente con incontro A+B.  
Vertical bolt America w/strike A+B.

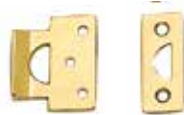

	150 mm	200 mm	250 mm	300 mm	400 mm	600 mm
FINITURA	OLV	OLV	OLV	OLV	OLV	OLV
IMBALLO	6	6	6	6	6	6

### Art. 6.0015.00

Extra per incontro tipo C per catenaccio America.  
Extra strike for America bolt.



	34x29 mm
FINITURA	OLV
IMBALLO	12

## SERIE CHIAVISTELLI



### Art. 5.4175

Chiavistello wc con visualizzatore L/O rosso-verde 62x39 mm.  
WC latch w/red-green signal 62x39 mm.

FINITURA IMBALLO	OTT 5	CR 5
---------------------	----------	---------



### Art. 6.0190

Mini chiavistello.  
Mini latch.

FINITURA IMBALLO	OLV 30	CR 30
---------------------	-----------	----------



### Art. 6.0195

Chiavistello con bordo 40x45 mm.  
Latch w/edge 40x45 mm.

FINITURA IMBALLO	OLV 30
---------------------	-----------

## SERIE LUCCHETTI E CHIUDIPIORTA



### Art. 3.4000

Lucchetti in ottone con tre chiavi.  
Padlock w/three keys.

40 mm

FINITURA IMBALLO	OLV 12
---------------------	-----------

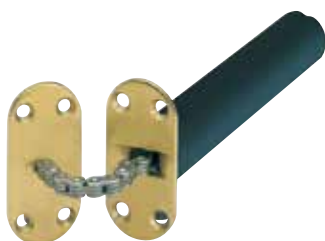

### Art. 6.5050

Chiudiporta a scomparsa con portata ideale di 50 kg.  
Hidden door closer 50 kg.

60x26x148 - ø 22 mm

FINITURA IMBALLO	OLV 1
---------------------	----------

# SERIE PARACOLPI E FERMAPORTA



## Art. 6.0040

Paracolpi a chiocciola per porta ø 50 mm - h. 30 mm.  
Chiocciola door stopper ø 50 mm - h. 30 mm.

FINITURA IMBALLO	OTT 20	CR 20	CRS 20
---------------------	-----------	----------	-----------



## Art. 6.0950

Paracolpi sfera grande ø 34 mm.  
Sphere door stopper ø 34 mm.

FINITURA IMBALLO	OLV 12	OGR 12	CR 12	CRS 12
---------------------	-----------	-----------	----------	-----------



## Art. 6.0960

Paracolpi ottone massiccio tipo lusso ø 30 mm - h. 37 mm.  
Solid brass door stopper ø 30 mm - h. 37 mm.

FINITURA IMBALLO	OLV 12	OGR 12	CRS 12
---------------------	-----------	-----------	-----------



## Art. 6.0045

Paracolpi a muro ø 40 mm - h. 71 mm.  
Wall door stopper ø 40 mm - h. 71 mm.

FINITURA IMBALLO	OLV 12	OGR 12	CRS 12
---------------------	-----------	-----------	-----------



## Art. 6.0999

Paracolpi sferico ø 24 mm - h. 28 mm.  
Sphere door stopper ø 24 mm - h. 28 mm.

FINITURA IMBALLO	OLV 25	OGR 25	CR 25	CRS 25
---------------------	-----------	-----------	----------	-----------



## Art. 6.1000

Paracolpi ondulato ø 24 mm - h. 22 mm.  
Wavy door stopper ø 24 mm - h. 22 mm.

FINITURA IMBALLO	OLV 25	OGR 25	CR 25	CRS 25
---------------------	-----------	-----------	----------	-----------

# SERIE BLOCCAPERSIANE



## Art. 6.0180

Gancio fermapersiane snodato.  
Articulated shutter stop hook.

	100 mm	150 mm
FINITURA IMBALLO	FERRO NR 10	FERRO NR 10



## Art. 6.0170

Gancio fermapersiane snodato.  
Articulated shutter stop hook.

	50 mm	75 mm	100 mm	125 mm	150 mm
FINITURA IMBALLO	OLV 20	OLV 20	OLV 20	OLV 20	OLV 10



## Art. 6.0010

Gancio fermapersiane.  
Shutter stop hook.

	60 mm	80 mm	100 mm	120 mm	140 mm	200 mm
FINITURA IMBALLO	OLV 25	OLV 25	OLV 25	OLV 25	OLV 25	OLV 25

	60 mm	80 mm	100 mm	120 mm	140 mm
FINITURA IMBALLO	CR 25	CR 25	CR 25	CR 25	CR 25



## Art. 6.0012

Catenaccio fermapersiane multiplo.  
Multiple shutter stop hook.

	da 60 a 140 mm
FINITURA IMBALLO	OLV 20

## Art. 5.4610

Cerniera fresata piana.  
Flat hinge.



	30x25 mm	30x30 mm	35x30 mm	35x35 mm
FINITURA IMBALLO	SAT 24	SAT 24	SAT 24	SAT 24
	40x30 mm	40x35 mm	40x40 mm	50x40 mm
FINITURA IMBALLO	SAT 24	SAT 24	SAT 24	SAT 24
	50x50 mm	60x50 mm	70x55 mm	80x60 mm
FINITURA IMBALLO	SAT 24	SAT 24	SAT 24	SAT 24

## Art. 5.4611

Cerniera mezza zancata.  
Half off-set hinge.



	35x35 mm	40x35 mm	40x40 mm
FINITURA IMBALLO	SAT 24	SAT 24	SAT 24
	50x40 mm	50x50 mm	60x50 mm
FINITURA IMBALLO	SAT 24	SAT 24	SAT 24

## Art. 5.4712

Cerniera doppio zancata.  
Double off-set hinge.



	35x35 mm	40x35 mm	40x40 mm	50x40 mm
FINITURA IMBALLO	SAT 24	SAT 24	SAT 24	SAT 24
	50x50 mm	60x50 mm	70x55 mm	
FINITURA IMBALLO	SAT 24	SAT 24	SAT 24	

## Art. 5.4600

Cerniera Biscotto con fermo 30x80 mm.  
Biscotto hinge 30x80 mm w/stop.

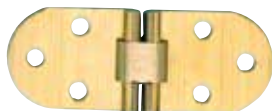

FINITURA IMBALLO	SAT 24
---------------------	-----------



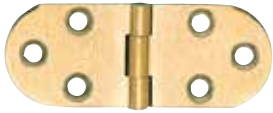

### Art. 5.4601

Cerniera Biscotto senza fermo 30x80 mm.  
Biscotto hinge 30x80 mm w/out stop.

FINITURA  
IMBALLO

SAT  
24

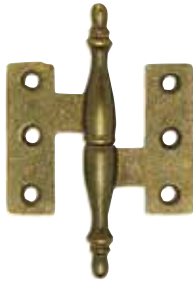

### Art. 5.4500 DX - Art. 5.4501 SX

Cerniera Barocco piccola 60x55 mm.  
Little Barocco hinge 60x55 mm.

FINITURA  
IMBALLO

BR  
24



### Art. 5.4520 DX - Art. 5.4521 SX

Cerniera Barocco zancata 60x55 mm.  
Barocco off-set hinge 60x55 mm.

FINITURA  
IMBALLO

BR  
24

### Art. 5.4530 DX - Art. 5.4531 SX

Cerniera Barocco zancata 90x60 mm.  
Barocco off-set hinge 90x60 mm.

FINITURA  
IMBALLO

BR  
24



### Art. 5.4715 DX - Art. 5.4716 SX

Cerniera Maschietto.  
Maschietto hinge.

190x100 mm

190x120 mm

FINITURA  
IMBALLO

OL  
6

OL  
6

**EXTRA PERNO IN OTTONE € 3.00 CAD.**



### Art. 5.4720 DX - Art. 5.4721 SX

Cerniera Poumelle.  
Poumelle hinge.

**80x50 mm      100x55 mm      100x60 mm**

FINITURA IMBALLO	OL 12	OL 12	OL 12
---------------------	----------	----------	----------

**120x60 mm      120x75 mm      140x70 mm**

FINITURA IMBALLO	OL 12	OL 12	OL 12
---------------------	----------	----------	----------



### Art. 5.4730 DX - Art. 5.4731 SX

Cerniera a libro.  
Book hinge.

**100x65 mm      120x70 mm      140x75 mm**

FINITURA IMBALLO	OL 12	OL 12	OL 12
---------------------	----------	----------	----------



### Art. 5.4735 DX - Art. 5.4736 SX

Cerniera a libro zancata.  
Book off-set hinge.

**100x65 mm      120x65 mm**

FINITURA IMBALLO	OL 12	OL 12
---------------------	----------	----------



### Art. 5.4740 DX - Art. 5.4741 SX

Cerniera Grossezza.  
Grossezza hinge.

**100 mm      120 mm      140 mm**

FINITURA IMBALLO	OL 12	OL 12	OL 12
---------------------	----------	----------	----------



### Art. 5.4750 DX - Art. 5.4751 SX

Cerniera per ascensore.  
Lift hinge.

**65x80 mm**

FINITURA IMBALLO	OL 12
---------------------	----------



**Art. 3.2400**

Portabito Big 280x140x120 mm.  
Big coat hook 280x140x120 mm.

FINITURA  
IMBALLO

OLV  
2

OGR  
2



### Art. 3.7260

Portabito Star.  
Star coat hook.

FINITURA IMBALLO	Z.OTT 12	Z.BR 12	Z.CR 12	Z.CRS 12	Z.BN 12
---------------------	-------------	------------	------------	-------------	------------



### Art. 3.2330

Portabito Ovale.  
Oval coat hook.

FINITURA IMBALLO	Z.OTT 12	Z.BR 12
---------------------	-------------	------------



### Art. 3.2340

Portabito Tondo.  
Round coat hook.

FINITURA IMBALLO	Z.OTT 12	Z.BR 12
---------------------	-------------	------------



### Art. 3.2496

Portabito singolo 108x145 mm.  
Single coat hook 108x145 mm.

FINITURA IMBALLO	Z.OTT 12	Z.BZ 12	Z.NIK 12
---------------------	-------------	------------	-------------



### Art. 3.2385

Portabito Rustico 125x70 mm.  
Rustic coat hook 125x70 mm.

FINITURA  
IMBALLO

FERRO NR  
12



### Art. 3.2355

Gancio Rustico 40x40 mm.  
Rustic hook 40x40 mm.

FINITURA  
IMBALLO

FERRO NR  
24



### Art. 3.2356

Gancio Rustico 2 posti - 40x100 mm.  
Rustic double hook 40x100 mm.

FINITURA  
IMBALLO

FERRO NR  
10



### Art. 3.2357

Gancio Rustico 3 posti - 40x150 mm.  
Rustic triple hook 40x150 mm.

FINITURA  
IMBALLO

FERRO NR  
10



**Art. 3.2380**

Portabito multiplo 145 mm.  
Multiple coat hook 145 mm.

FINITURA  
IMBALLO

OLV  
10



**Art. 3.2350**

Gancio Marina 80x70x30.  
Marina hook 80x70x30.

FINITURA  
IMBALLO

Z.OTT  
12

Z.CR  
12



### Art. 6.1016

Gancio da cucina 46x38 mm.  
Kitchen hook 46x38 mm.

**6.1017**  
40x30 mm

**6.1018**  
34x22 mm

FINITURA IMBALLO	OL 20	OL 20	OL 20
FINITURA IMBALLO	CR 20	CR 20	CR 20



### Art. 6.1014

Gancio da cucina doppio 40x19x50 mm.  
Double kitchen hook 40x19x50 mm.

FINITURA IMBALLO	OL 20	CR 20
---------------------	----------	----------



### Art. 6.1059

Gancio per tendaggi leggero 40x15 mm.  
Curtain hook light 40x15 mm.

**6.1060**  
35x14 mm

**6.1062**  
30x11 mm

**6.1063**  
24x9 mm

FINITURA IMBALLO	OL 50	OL 50	OL 50	OL 50
---------------------	----------	----------	----------	----------



### Art. 6.1149

Gancio per tendaggi pesante 50x44x25 mm.  
Curtain hook heavy 50x44x25 mm.

**6.1151**  
38x33x20 mm

**6.1152**  
33x26x15 mm

FINITURA IMBALLO	OTT 30	OLV 30	OLV 30
---------------------	-----------	-----------	-----------



#### Art. 6.1146

Gancio per tendaggi con rosetta Barocco 45x90x65 mm.  
Barocco curtain hook w/rose 45x90x65 mm.

FINITURA  
IMBALLO

Z.OTT  
10

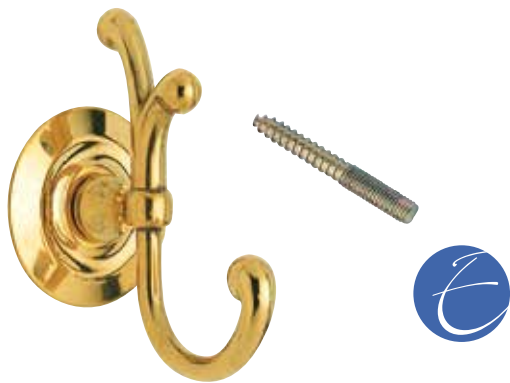

#### Art. 6.1147

Gancio per tendaggi con rosetta liscia 45x90x65 mm.  
Curtain hook w/rose 45x90x65 mm.

FINITURA  
IMBALLO

Z.OTT  
10



#### Art. 6.1200

Embrasse Edelweiss 40x20x16 mm.  
Edelweiss embrasse 40x20x16 mm.

FINITURA  
IMBALLO

OLV  
30



#### Art. 6.1390

Embrasse Giglio con sfera 55x25x20 mm.  
Giglio embrasse w/sphere 55x25x20 mm.

FINITURA  
IMBALLO

OLV  
30

NR  
30



ANELLI PER TENDE



**Art. 6.4200**

Anelli per bastoni reggitende ø est. 45 mm - ø int. 32 mm.  
Rings for curtain stick ø est. 45 mm - ø int. 32 mm.

FINITURA IMBALLO	OLV 60	BR 60	CR 60
---------------------	-----------	----------	----------



**Art. 6.4250**

Anelli per bastoni reggitende.  
Rings for curtain stick.

ø int. 25 mm

ø int. 32 mm

FINITURA IMBALLO	FERRO NR 50	FERRO NR 50
---------------------	----------------	----------------

MENSOLE PER TENDE



**Art. 6.1570**

Mensola estensibile 80/115 mm.  
Adjustable shelf 80/115 mm.

**6.1571**

80/160 mm

FINITURA IMBALLO	FERRO NR 20	FERRO NR 20
---------------------	----------------	----------------



**Art. 6.1572**

Mensola doppia 115 mm.  
Double shelf 115 mm.

FINITURA IMBALLO	FERRO NR 20
---------------------	----------------

# SERIE SUPPORTI PER CORRIMANO



## Art. 6.0070

Supporto per corrimano quadro.  
Square rails support.

FINITURA IMBALLO	OLV 12	BR 12	CR 12	CRS 12
---------------------	-----------	----------	----------	-----------



## Art. 6.0071

Supporto per corrimano con viti in vista.  
Rails support w/visible screws.

FINITURA IMBALLO	OLV 12	OGR 12	CRS 12
---------------------	-----------	-----------	-----------

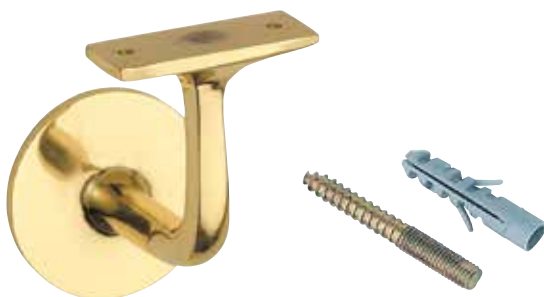

## Art. 6.0085

Supporto Slim per corrimano con testa piana.  
Slim rails support w/plain head.

FINITURA IMBALLO	OLV 12	OGR 12
---------------------	-----------	-----------



### Art. 6.0073

Supporto per corrimano con testa piana e base ø 56 mm.  
Rails support flat head - ø 56 mm.

FINITURA IMBALLO	OLV 12	OGR 12	CR 12	CRS 12
---------------------	-----------	-----------	----------	-----------



### Art. 6.0074

Supporto per corrimano con testa concava e base ø 56 mm.  
Rails support curved head - ø 56 mm

FINITURA IMBALLO	OLV 12	OGR 12	CR 12	CRS 12
---------------------	-----------	-----------	----------	-----------



### Art. 6.0080

Supporto per corrimano con testa piana e base ø 53 mm.  
Rails support flat head - ø 53 mm.

FINITURA IMBALLO	OLV 12	OGR 12	CR 12	CRS 12
---------------------	-----------	-----------	----------	-----------



### Art. 6.0081

Supporto per corrimano con testa concava e base ø 53 mm.  
Rails support curved head - ø 53 mm.

FINITURA IMBALLO	OLV 12	OGR 12	CR 12	CRS 12
---------------------	-----------	-----------	----------	-----------



### Art. 6.0075

Supporto per corrimano con testa piana e base ø 43 mm.  
Rails support flat head - ø 43 mm.

FINITURA  
IMBALLO

OLV  
12



### Art. 6.0088

Supporto per corrimano passante dritto per tubo ø 35 mm - sporgenza 106 mm e base ø 56 mm.

Straight passing rails support ø 35 mm - lenght 106 mm - base ø 56 mm.

FINITURA  
IMBALLO

OLV  
6

OGR  
6

CR  
6

CRS  
6



### Art. 6.0089

Supporto per corrimano passante curvo per tubo ø 35 mm - sporgenza 115 mm e base ø 56 mm.

Curved passing rails support ø 35 mm - lenght 115 mm - base ø 56 mm.

FINITURA  
IMBALLO

OLV  
6

OGR  
6

CR  
6

CRS  
6



**Art. 6.1440**

Reggimensola artistica 125x172x22 mm.  
Artistic shelf 125x172x22 mm.

FINITURA  
IMBALLO

OLV  
6



### Art. 6.1420

Reggimensola per vetro fresata  $\varnothing$  23 mm - spessore max 10 mm.  
Glass shelf  $\varnothing$  23 mm - max height 10 mm.

FINITURA IMBALLO	OLV 25	CROMO 25	CRS 25
---------------------	-----------	-------------	-----------



### Art. 6.1430

Reggimensola per specchio  $\varnothing$  25 mm.  
Mirror shelf  $\varnothing$  25 mm.

FINITURA IMBALLO	OLV 25	CR 25	CRS 25
---------------------	-----------	----------	-----------



### Art. 6.1435

Reggimensola per vetrine  $\varnothing$  20 mm - spessore max 8 mm.  
Showcase shelf  $\varnothing$  20 mm - max height 8 mm.

FINITURA IMBALLO	OLV 25	CR 25	CRS 25
---------------------	-----------	----------	-----------

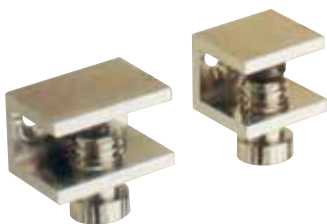

### Art. 6.1460

Reggimensola a morsetto normale - spessore max 10 mm.  
Shelf max height 10 mm.

**6.1460** 15x15 mm    **6.1461** 15x20 mm    **6.1462** 15x25 mm    **6.1463** 15x30 mm    **6.1464** 15x35 mm

FINITURA IMBALLO	OL 24	OL 24	OL 24	OL 24	OL 24
---------------------	----------	----------	----------	----------	----------

FINITURA IMBALLO	CR 24	CR 24	CR 24	CR 24	CR 24
---------------------	----------	----------	----------	----------	----------



**Art. 6.1560**

Reggimensola Smart con foro 4 ma, vite e tassello.  
Smart shelf.

FINITURA IMBALLO	OLV 12	SAT 12	BR 12	ANT 12	CR 12	CRS 12	NIK MAT 12	BN 12	NR 12
---------------------	-----------	-----------	----------	-----------	----------	-----------	---------------	----------	----------

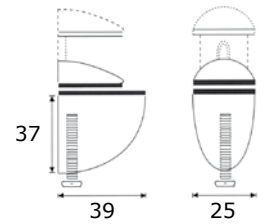

**Art. 6.1582**

Reggimensola Tuc piccolo 37x39x25 mm - spessore max 14 mm.  
Tuc shelf 37x39x25 mm little - max height 14 mm.

FINITURA IMBALLO	CR 10	CRS 10	NIK MAT 10
---------------------	----------	-----------	---------------

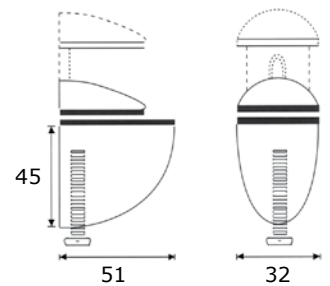

**Art. 6.1583**

Reggimensola Tuc grande 45x51x32 mm - spessore max 22 mm.  
Tuc shelf 37x39x25 mm big - max height 22 mm.

FINITURA IMBALLO	NIK MAT 10
---------------------	---------------

PINZE



**Art. 5.5340**

Pinza con incontro ad avvitare completa di viti e tassello.  
Door stopper - with strike.

FINITURA IMBALLO	NYLON NR 25
---------------------	----------------

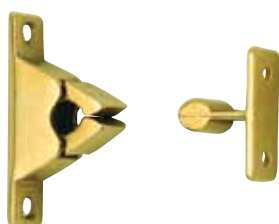

**Art. 6.0001**

Pinza fermaporta con incontro ad avvitare.  
Door stopper - with strike.

FINITURA IMBALLO	OL 25	BR 25
---------------------	----------	----------

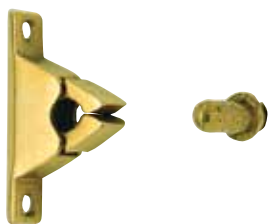

**Art. 6.0002**

Pinza fermaporta con incontro ad piombare.  
Door stopper - with strike.

FINITURA IMBALLO	OL 25	BR 25
---------------------	----------	----------

PARACOLPI

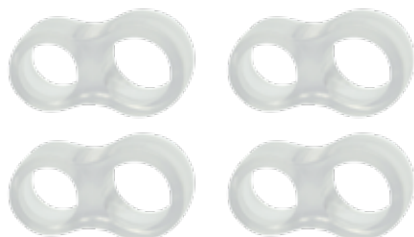

**Art. 6.0990**

Antiurto in gomma trasparente per maniglie - confezione 4 pezzi.  
Plastic handle repair - 4 pcs.

FINITURA IMBALLO	TRASPARENTE 50 confezioni
---------------------	------------------------------

DISTANZIALI



**Art. 7.0310**

Distanziale per targhe ø 14 mm.  
Spacer ø 14 mm.

FINITURA IMBALLO	OLV 25	SAT 25	OGR 25	CR 25	CRS 25
---------------------	-----------	-----------	-----------	----------	-----------



## CHIODI



### Art. 6.3300

Chiodo a piramide per portone 20x20 mm.  
Brass nail 20x20 mm.

FINITURA IMBALLO	OL 24	BR 24
---------------------	----------	----------

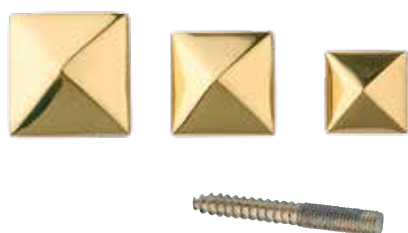

### Art. 6.3305

Chiodo a piramide con vite separata.  
Brass nail w/separate screw.

20x20 mm      25x25 mm      30x30 mm

FINITURA IMBALLO	OL 20	OL 20	OL 20
---------------------	----------	----------	----------

FINITURA IMBALLO	ANT 20	ANT 20	ANT 20
---------------------	-----------	-----------	-----------

## COPRIDADI



### Art. 6.0051

Borchia copridado tonda ø 30 mm.  
Round cover ø 30 mm.

FINITURA IMBALLO	OLV 24	OGR 24	CRS 24
---------------------	-----------	-----------	-----------



## MANIGLIE BLOCCO

### Art. 6.0120

Maniglia blocco.  
Interlock handle.

#### Art. 6.0120

DX

#### Art. 6.0121

SX

FINITURA IMBALLO	OL 12	BR 12	OL 12	BR 12
---------------------	----------	----------	----------	----------

## CRICCHETTI



### Art. 6.0021

Cricchetto per sopra luce con incontro ad angolo.  
Angle latch w/strike.

FINITURA	OL
IMBALLO	25

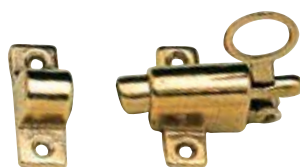

### Art. 6.0022

Cricchetto per sopra luce con incontro piano.  
Latch w/plan strike.

FINITURA	OL
IMBALLO	25



### Art. 6.0027

Cricchetto a sfera.  
Double ball ratchet.

	42 mm	50 mm	60 mm	70 mm
FINITURA	OLV	OLV	OLV	OLV
IMBALLO	24	24	24	24

## POZZUOLI SENZA MOLLA



### Art. 6.0061

Pozzuolo senza molla.  
Trap w/out spring.

	ø 10 mm	ø 14 mm
FINITURA	OL	OL
IMBALLO	50	50

## POZZUOLI CON MOLLA



### Art. 6.0060

Pozzuolo con molla.  
Trap with spring.

	ø 20 mm	ø 22 mm
FINITURA	OL	OL
IMBALLO	50	50

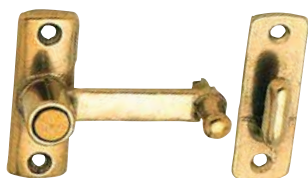
**Art. 6.0100**

Tavellino a scatto con incontro.  
Bolt w/strike.

	5 mm	10 mm	15 mm	20 mm	25 mm	30 mm
FINITURA IMBALLO	OL 25	OL 25	OL 25	OL 25	OL 25	OL 25
FINITURA IMBALLO	BR 25	BR 25	BR 25	BR 25	BR 25	BR 25

**Art. 6.0108**

Tavellino a scatto tipo pesante.  
Heavy bolt.

	25 mm	30 mm
FINITURA IMBALLO	OL 25	OL 25
FINITURA IMBALLO	BZ 25	BZ 25

**Art. 6.0110**

Cavallotto a rullo.  
Roller.

	20 mm	25 mm	30 mm
FINITURA IMBALLO	OL 25	OL 25	OL 25
€			

BOCCHETTE

LINEA

COPPIA NOTTOLINI WC

MARTELLINE/CREMONESI

MINI MARTELLINE

SEGRETINI

ROSETTE DK

SICURDK

PLACCHE  
MARTELLINE/CREMONESI

PLACCHE MANIGLIA

FERRAMENTA PER  
CREMONESI E DK

FERRAMENTA  
VITI E FERRI

Cottali

# SERIE BOCCHETTE



## Art. 2.9260

Bocchetta ø 55 mm ad avvitare con foro asola.  
Screwed escutcheon ø 55 mm - key hole.

FINITURA IMBALLO	OLV 10	OGR 10	CRS 10



## Art. 2.9260.18

Bocchetta ø 55 mm ad avvitare con foro cilynder.  
Screwed escutcheon ø 55 mm - cilynder hole.

FINITURA IMBALLO	OLV 10	OGR 10	CRS 10



## Art. 2.9260.32

Bocchetta ø 55 mm ad avvitare senza foro.  
Screwed escutcheon ø 55 mm - dummy.

FINITURA IMBALLO	OLV 10	OGR 10	CRS 10



## Art. 2.9225

Bocchetta ø 60 mm ad avvitare con foro asola.  
Screwed escutcheon ø 60 mm - key hole.

FINITURA IMBALLO	OLV 12	OGR 12	ORO ANT 12



## Art. 2.9225.18

Bocchetta ø 60 mm ad avvitare con foro cilynder.  
Screwed escutcheon ø 60 mm - cilynder hole.

FINITURA IMBALLO	OLV 12	OGR 12	ORO ANT 12



## Art. 2.9225.32

Bocchetta ø 60 mm ad avvitare senza foro.  
Screwed escutcheon ø 60 mm - dummy.

FINITURA IMBALLO	OLV 12	OGR 12	ORO ANT 12



## Art. 2.9070

Bocchetta "bombata" ø 50 mm ad avvitare con foro asola.  
"Curved" screwed escutcheon ø 50 mm - key hole.

FINITURA IMBALLO	OLV 10	OGR 10	CRS 10



## Art. 2.9070.18

Bocchetta "bombata" ø 50 mm ad avvitare con foro cilynder.  
"Curved" screwed escutcheon ø 50 mm - cilynder hole.

FINITURA IMBALLO	OLV 10	OGR 10	CRS 10



## Art. 2.9070.32

Bocchetta "bombata" ø 50 mm ad avvitare senza foro.  
"Curved" screwed escutcheon ø 50 mm - dummy.

FINITURA IMBALLO	OLV 10	OGR 10	CRS 10



### Art. 2.9180

Bocchetta "con bordo" ø 50 mm ad avvitare con foro asola.

"Edged" screwed escutcheon ø 50 mm - key hole.

FINITURA IMBALLO	OLV 12	OGR 12	CRS 12
---------------------	-----------	-----------	-----------



### Art. 2.9180.18

Bocchetta "con bordo" ø 50 mm ad avvitare con foro cilynder.

"Edged" screwed escutcheon ø 50 mm - cilynder hole.

FINITURA IMBALLO	OLV 12	OGR 12	CRS 12
---------------------	-----------	-----------	-----------



### Art. 2.9180.32

Bocchetta "con bordo" ø 50 mm ad avvitare senza foro.

"Edged" screwed escutcheon ø 50 mm - dummy.

FINITURA IMBALLO	OLV 12	OGR 12	CRS 12
---------------------	-----------	-----------	-----------



### Art. 2.9035

Bocchetta ø 45 mm a pressione con foro asola.  
Pressured fixed escutcheon ø 45 mm - key hole.

FINITURA IMBALLO	OLV 10	OGR 10	CRS 10
---------------------	-----------	-----------	-----------



### Art. 2.9035.18

Bocchetta ø 45 mm a pressione con foro cilynder.  
Pressured fixed escutcheon ø 45 mm - cilynder hole.

FINITURA IMBALLO	OLV 10	OGR 10	CRS 10
---------------------	-----------	-----------	-----------



### Art. 2.9035.32

Bocchetta ø 45 mm a pressione senza foro.  
Pressured fixed escutcheon ø 45 mm - dummy.

FINITURA IMBALLO	OLV 10	OGR 10	CRS 10
---------------------	-----------	-----------	-----------



### Art. 2.9032

Bocchetta ø 50 mm a pressione con foro asola.  
Pressured fixed escutcheon ø 50 mm - key hole.

FINITURA IMBALLO	OLV 10	OGR 10	CRS 10
---------------------	-----------	-----------	-----------



### Art. 2.9032.18

Bocchetta ø 50 mm a pressione con foro cilynder.  
Pressured fixed escutcheon ø 50 mm - cilynder hole.

FINITURA IMBALLO	OLV 10	OGR 10	CRS 10
---------------------	-----------	-----------	-----------



### Art. 2.9032.32

Bocchetta ø 50 mm a pressione senza foro.  
Pressured fixed escutcheon ø 50 mm - dummy.

FINITURA IMBALLO	OLV 10	OGR 10	CRS 10
---------------------	-----------	-----------	-----------



### Art. 2.9030

Bocchetta ø 50 mm ad avvitare con foro asola.  
Screwed escutcheon ø 50 mm - key hole.

FINITURA IMBALLO	OLV 10	OGR 10	CRS 10
---------------------	-----------	-----------	-----------



### Art. 2.9030.18

Bocchetta ø 50 mm ad avvitare con foro cilynder.  
Screwed escutcheon ø 50 mm - cilynder hole.

FINITURA IMBALLO	OLV 10	OGR 10	CRS 10
---------------------	-----------	-----------	-----------



### Art. 2.9030.32

Bocchetta ø 50 mm ad avvitare senza foro.  
Screwed escutcheon ø 50 mm - dummy.

FINITURA IMBALLO	OLV 10	OGR 10	CRS 10
---------------------	-----------	-----------	-----------



### Art. 2.9210

Bocchetta quadrata 45x45 mm a pressione con foro asola.  
Square pressured fixed escutcheon 45x45 mm - key hole.

FINITURA IMBALLO	OTT 10	OGR 10	CR 10	CRS 10
---------------------	-----------	-----------	----------	-----------



### Art. 2.9210.18

Bocchetta quadrata 45x45 mm a pressione con foro cilynder.  
Square pressured fixed escutcheon 45x45 mm - cilynder hole.

FINITURA IMBALLO	OTT 10	OGR 10	CR 10	CRS 10
---------------------	-----------	-----------	----------	-----------



### Art. 2.9210.32

Bocchetta quadrata 45x45 mm a pressione senza foro.  
Square pressured fixed escutcheon 45x45 mm - dummy.

FINITURA IMBALLO	OTT 10	OGR 10	CR 10	CRS 10
---------------------	-----------	-----------	----------	-----------



### Art. 2.9220

Bocchetta quadrata 50x50 mm a pressione con foro asola.  
Square pressured fixed escutcheon 50x50 mm - key hole.

FINITURA IMBALLO	OTT 10	OGR 10	CR 10	CRS 10
---------------------	-----------	-----------	----------	-----------



### Art. 2.9220.18

Bocchetta quadrata 50x50 mm a pressione con foro cilynder.  
Square pressured fixed escutcheon 50x50 mm - cilynder hole.

FINITURA IMBALLO	OTT 10	OGR 10	CR 10	CRS 10
---------------------	-----------	-----------	----------	-----------



### Art. 2.9220.32

Bocchetta quadrata 50x50 mm a pressione senza foro.  
Square pressured fixed escutcheon 50x50 mm - dummy.

FINITURA IMBALLO	OTT 10	OGR 10	CR 10	CRS 10
---------------------	-----------	-----------	----------	-----------



### Art. 2.9005

Rosetta  $\varnothing$  65 mm ad avvitare - foro  $\varnothing$  16.  
Screwed rose  $\varnothing$  65 mm - hole  $\varnothing$  16 mm.

FINITURA IMBALLO	OLV 6	OGR 6	CRS 6
---------------------	----------	----------	----------



### Art. 2.9040

Bocchetta ovale 61x31 mm con foro asola.  
Oval pressured fixed escutcheon 61x31 mm - key hole.

FINITURA IMBALLO	OLV 10	OGR 10	CRS 10	ALL. BZ 10	ALL. ARG 10
---------------------	-----------	-----------	-----------	---------------	----------------



### Art. 2.9040.18

Bocchetta ovale 61x31 mm con foro cilynder.  
Oval pressured fixed escutcheon 61x31 mm - cilynder hole.

FINITURA IMBALLO	OLV 10	OGR 10	CRS 10	ALL. BZ 10	ALL. ARG 10
---------------------	-----------	-----------	-----------	---------------	----------------



### Art. 2.9165

Bocchetta rettangolare 61x31 mm con foro asola.  
Rectangular pressured fixed escutcheon 61x31 mm - key hole.

FINITURA IMBALLO	OLV 12	OGR 12	CRS 12
---------------------	-----------	-----------	-----------



### Art. 2.9165.18

Bocchetta rettangolare 61x31 mm con foro cilynder.  
Rectangular pressured fixed escutcheon 61x31 mm - cilynder hole.

FINITURA IMBALLO	OLV 12	OGR 12	CRS 12
---------------------	-----------	-----------	-----------



# SERIE COPPIA NOTTOLINI WC



## Art. 3.2876

Coppia nottolino wc con rosetta quadra 45x45 mm a pressione.  
WC snib pressured fixed square escutcheon 45x45 mm.

FINITURA IMBALLO	OLV 5	CR 5	CRS 5
---------------------	----------	---------	----------

## Art. 3.2875

Coppia nottolino wc con rosetta quadra 50x50 mm a pressione.  
WC snib pressured fixed square escutcheon 50x50 mm.

FINITURA IMBALLO	OLV 5	CR 5	CRS 5
---------------------	----------	---------	----------



## Art. 3.2850

Coppia nottolino wc con rosetta ø 50 mm ad avvitare con imp. pesante.  
WC heavy snib on screwed escutcheon ø 50 mm.

FINITURA IMBALLO	OLV 5	OGR 5	CRS 5
---------------------	----------	----------	----------



## Art. 3.2860

Coppia nottolino wc con rosetta ø 50 mm ad avvitare.  
WC snib screwed escutcheon ø 50 mm.

FINITURA IMBALLO	OLV 5	OGR 5	CRS 5
---------------------	----------	----------	----------



## Art. 3.2861

Coppia nottolino wc con rosetta ø 45 mm a pressione.  
WC snib pressured fixed escutcheon ø 45 mm.

FINITURA IMBALLO	OLV 5	OGR 5	CRS 5
---------------------	----------	----------	----------



## Art. 3.2861/LO

Coppia nottolino wc con visualizzatore rosetta ø 45 mm a pressione.  
WC snib pressured fixed escutcheon ø 45 mm with viewer.

FINITURA IMBALLO	OLV 5	OGR 5	CRS 5
---------------------	----------	----------	----------



## Art. 3.2872

Coppia nottolino wc con rosetta ø 32 mm ad avvitare.  
WC snib screwed escutcheon ø 32 mm.

FINITURA IMBALLO	OLV 5	OGR 5	CRS 5
---------------------	----------	----------	----------



## SERIE MARTELLINE / CREMONESI

### RICCIO

#### Art. 4.3522

Cremonese o martellina con placca "con bordo".  
Window handle on "edged" plate.

FINITURA IMBALLO	OLV 2	ANT BL 2	ORO ANT 2
---------------------	----------	-------------	--------------

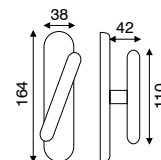

### TOSCANA

#### Art. 4.2712

Cremonese o martellina con placca "12".  
Window handle on plate "12".

FINITURA IMBALLO	OLV 2	ANT BL 2	ORO ANT 2
---------------------	----------	-------------	--------------

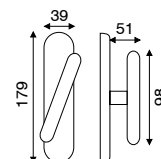

### LUCCA

#### Art. 4.4711

Cremonese o martellina con placca "11".  
Window handle on plate "11".

FINITURA IMBALLO	OLV 2	ANT BL 2	ORO ANT 2
---------------------	----------	-------------	--------------

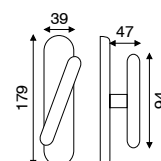

## ENEZIA



### Art. 4.2911

Cremonese o martellina con placca "11".  
Window handle on plate "11".

FINITURA IMBALLO	OLV 2	ANT BL 2	ORO ANT 2	ARG ANT 2
---------------------	----------	-------------	--------------	--------------

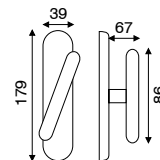

## MALAGA



### Art. 4.3311

Cremonese o martellina con placca "11".  
Window handle on plate "11".

FINITURA IMBALLO	OLV 2	OGR 2
---------------------	----------	----------

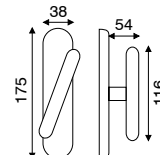

## ANGY



### Art. 4.9410

Cremonese o martellina.  
Window handle.

FINITURA IMBALLO	OGR 2
---------------------	----------

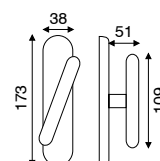

## FLORA



### Art. 4.2810

Cremonese o martellina.  
Window handle.

FINITURA	OF
IMBALLO	6

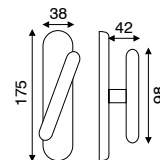

## BAROCCO

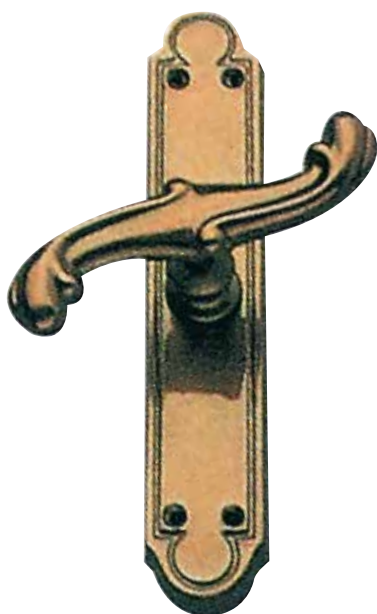

### Art. 4.5910

Cremonese o martellina.  
Window handle.

FINITURA	BR
IMBALLO	6

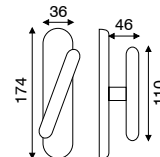

## PENDENTE



### Art. 4.6619

Cremonese o martellina con placca "stampata" "19".  
Window handle on "molded" plate "19".

FINITURA	OLV	OGR	CRS
IMBALLO	6	6	6

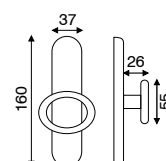



## ERIKA

### Art. 4.4210

Cremonese o martellina.  
Window handle.

FINITURA	OLV	OGR	CRS
IMBALLO	2	2	2

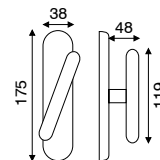

## ERIKA BIC

### Art. 4.4210 BIC

Cremonese o martellina.  
Window handle.

FINITURA	OLV/SAT	CR/CRS
IMBALLO	2	2

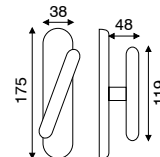

## ALEX

### Art. 4.4310

Cremonese o martellina.  
Window handle.

FINITURA	OLV	OGR
IMBALLO	2	2

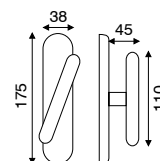

## RIO



### Art. FI 2.8210

Cremonese o martellina.  
Window handle.

FINITURA	OLV	OGR
IMBALLO	2	2

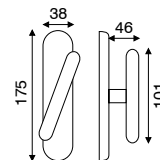

## PARO



### Art. 4.6819

Cremonese o martellina.  
Window handle.

FINITURA	OLV	OGR
IMBALLO	2	2

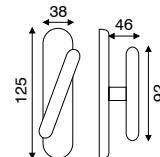

## CLASSIC



### Art. 4.2510

Cremonese o martellina.  
Window handle.

FINITURA	OLV	OGR	CRS
IMBALLO	2	2	2

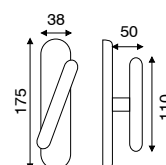



## SILVIA



### Art. 4.2010

Cremonese o martellina.  
Window handle.

FINITURA	OLV	OGR	CRS
IMBALLO	2	2	2

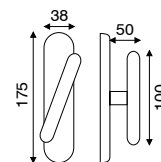

## SEDNA

### Art. 4.9910

Cremonese o martellina.  
Window handle.

FINITURA	OLV	OGR	CRS
IMBALLO	2	2	2

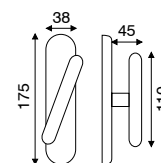

## EVA

### Art. 4.6310

Cremonese o martellina.  
Window handle.

FINITURA	OLV	OGR
IMBALLO	2	2

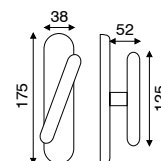



## VEGA

### Art. 4.1110

Cremonese o martellina.  
Window handle.

FINITURA	OLV	OGR	CRS
IMBALLO	2	2	2

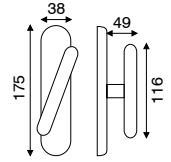

## KAROL

### Art. 4.9510

Cremonese o martellina.  
Window handle.

FINITURA	OLV	OGR	CRS
IMBALLO	2	2	2

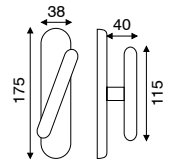

## MIRIAM

### Art. 4.8410

Cremonese o martellina.  
Window handle.

FINITURA	OLV	OGR	CRS
IMBALLO	2	2	2

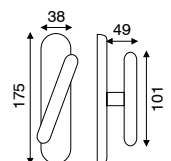



## DRÒ



### Art. 4.8710

Cremonese o martellina.  
Window handle.

FINITURA	OLV	OGR	CRS
IMBALLO	2	2	2

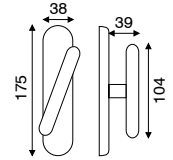

## ALICE



### Art. 4.2210

Cremonese o martellina.  
Window handle.

FINITURA	OLV	OGR	CRS
IMBALLO	2	2	2

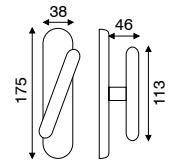

## RIVA



### Art. FI 2.7410

Cremonese o martellina.  
Window handle.

FINITURA	OLV	OGR	CRS
IMBALLO	2	2	2

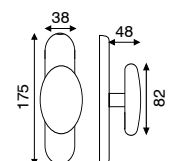



## GOCCIA

### Art. FI 2.2110

Cremonese o martellina.  
Window handle.

FINITURA	OLV/SAT	CR/CRS
IMBALLO	2	2

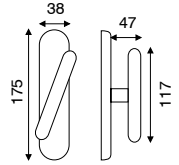

## LIZ

### Art. FI 2.4838

Cremonese o martellina con placca rettangolare "38".  
Window handle on rectangular plate "38".

FINITURA	Z.CRS
IMBALLO	2

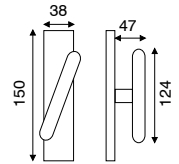

## ELLE

### Art. FI 2.8038

Cremonese o martellina con placca rettangolare "38".  
Window handle on rectangular plate "38".

FINITURA	Z.CRS
IMBALLO	2

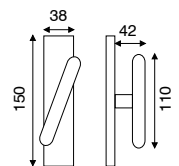



## BASKET

### Art. 4.8510

Cremonese o martellina.  
Window handle.

FINITURA	FERRO NR
IMBALLO	2

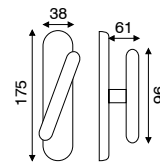

## OMEGA

### Art. FI 2.1910

Cremonese o martellina.  
Window handle.

FINITURA	ALL. BR	ALL. ARG
IMBALLO	10	10

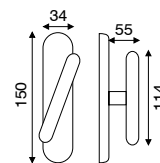

## THEA

### Art. 4.6410

Cremonese o martellina.  
Window handle.

FINITURA	ALL. BR	ALL. ARG
IMBALLO	10	10

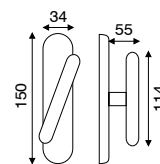



**Art. 4.1120.70**

Mini martellina Vega con rosetta ovale e viti a vista - int. 43 mm.  
Mini window handle Vega on oval rose with visible screws - int. 43 mm.

FINITURA IMBALLO	OLV 6	OGR 6	CRS 6
---------------------	----------	----------	----------



**Art. 4.1320.70**

Mini martellina Altwien con rosetta ovale e viti a vista - int. 43 mm.  
Mini window handle Altwien on oval rose with visible screws - int. 43 mm.

FINITURA IMBALLO	OLV 6	OGR 6	CRS 6
---------------------	----------	----------	----------



**Art. 4.6720.70**

Mini martellina Elegant con rosetta ovale e viti a vista - int. 43 mm.  
Mini window handle Elegant on oval rose with visible screws - int. 43 mm.

FINITURA IMBALLO	OLV 6	OGR 6	CRS 6
---------------------	----------	----------	----------



**Art. 4.0110**

Martellina universale con rosetta ovale e viti a vista - int. 43 mm.  
Universal window handle on oval rose with visible screws - int. 43 mm.

FINITURA IMBALLO	OLV 6	OGR 6	CRS 6
---------------------	----------	----------	----------



**Art. 4.1120**

Segretino Vega con rosetta ovale e viti a vista - Q7.  
Window handle Vega on oval rose with visible screws - Q7.

FINITURA IMBALLO	OLV 6	OGR 6	CRS 6
---------------------	----------	----------	----------



**Art. 4.1320**

Segretino Altwien con rosetta ovale e viti a vista - Q7.  
Window handle Altwien on oval rose with visible screws - Q7.

FINITURA IMBALLO	OLV 6	OGR 6	CRS 6
---------------------	----------	----------	----------



**Art. 4.6720**

Segretino Elegant con rosetta ovale e viti a vista - Q7.  
Window handle Elegant on oval rose with visible screws - Q7.

FINITURA IMBALLO	OLV 6	OGR 6	CRS 6
---------------------	----------	----------	----------

## SERIE ROSETTE DK



Cod. 65

Rosetta per dk ovale per meccanismo acciaio 61x31 mm.  
Dk oval rose for steel mechanism 61x31 mm.



Cod. 70

Rosetta per dk rettangolare 61x31 mm.  
Dk rectangular rose 61x31 mm.



Cod. 70 PES

Rosetta per dk rettangolare pesante 61x31 mm.  
Dk heavy rectangular rose 61x31 mm.

## SERIE SICURDK



### Art. 9.0067

Sistema antieffrazione con comando a pulsante.  
Burglary system with push button.

Il SicurdK si abbina ai movimenti DK in acciaio premontati da 4 o 8 scatti.

FINITURA  
IMBALLO

OLV  
10

CRS  
10

Si compone di:

A - Blocco Pulsante

B - Rosetta ovale per SicurdK 31x61 mm h.19 mm

C - Kit fissaggio composto da n° 2 viti e ferro  $\sphericalangle$  7

Questo dispositivo mantiene la maniglia in posizione di blocco.

L'azionamento e la rotazione si dispongono premendo il pulsante e liberando il blocco sul quadro del DK.

Il sistema è acquistabile separatamente in apposite confezioni.

Il prezzo è riferito al singolo sistema, mentre l'immagine della maniglia è puramente dimostrativa.

**N.B. : INDICARE SEMPRE SU CHE MODELLO SI INTENDE INSTALLARE IL SISTEMA,  
O COMUNICARE IL FORO CHE SI NECESSITA -  $\varnothing$  22 O 24 MM**

## SERIE PLACCHE MARTELLINE/CREMONESI



### Cod. 10

Placca per cremonese 175x38 mm.  
Window handle plate 175x38 mm.



### Cod. 11

Placca per cremonese 179x39 mm.  
Window handle plate 179x39 mm.



### Cod. 12

Placca per cremonese 179x39 mm.  
Window handle plate 179x39 mm.



### Cod. 19

Placca per cremonese 160x37 mm.  
Window handle plate 160x37 mm.



### Cod. 21

Placca per cremonese per aste esterne 141x35 mm.  
Window handle plate for external rods 141x35 mm.



### Cod. 22

Placca per cremonese 164x38 mm.  
Window handle plate 164x38 mm.



### Cod. 38

Placca per cremonese 150x38 mm.  
Window handle plate 150x38 mm.

## SERIE PLACCHE MANIGLIA



### Cod. 2.0008.27

Placca "G" per maniglie 270x55 mm.  
Handle plate "G" 270x55 mm.



### Cod. 16

Placca "Q" per maniglie 243x43 mm.  
Handle plate "Q" 243x43 mm.



### Cod. A1

Placca "A1" per maniglie 206x38 mm.  
Handle plate "A1" 206x38 mm.



### Cod. A2

Placca "A2" per maniglie 208x40 mm.  
Handle plate "A2" 208x40 mm.



### Cod. FERRO

Placca "FERRO" per maniglie 292x37 mm.  
Handle plate "FERRO" 292x37 mm.



## SERIE PLACCHE MANIGLIA



### Cod. 10

Placca per maniglie 230x38 mm.  
Handle plate 230x38 mm.



### Cod. 11

Placca per maniglie 240x42 mm.  
Handle plate 240x42 mm.



### Cod. 12

Placca per maniglie 247x38 mm.  
Handle plate 247x38 mm.



### Cod. 13

Placca per maniglie 246x39 mm.  
Handle plate 246x39 mm.



### Cod. 2.0009

Placca "K" per maniglie 247x47 mm.  
Handle plate "K" 247x47 mm.



### Cod. 17

Placca per maniglie 232x28 mm.  
Handle plate 232x28 mm.

## SERIE PLACCHE MANIGLIA



### Cod. 19

Placca per maniglie 224x35 mm.  
Handle plate 224x35 mm.



### Cod. 22

Placca per maniglie 253x43 mm.  
Handle plate 253x43 mm.



### Cod. 32

Placca "DECÒ" per maniglie 290x55 mm.  
Handle plate "DECÒ" 290x55 mm.



### Cod. 33

Placca "R" per maniglie 300x55 mm.  
Handle plate "R" 300x55 mm.



### Cod. 34

Placca "J" per maniglie 395x75 mm.  
Handle plate "J" 395x75 mm.



### Cod. 2.0007

Placca "B" per maniglie 270x55 mm.  
Handle plate "B" 270x55 mm.

Cottali



## Art. 9.0070

Gioco gratz fori.  
System for window handle.

IMBALLO 20



## Art. 9.0090

Gioco gratz bussole.  
System for window handle.

IMBALLO 20

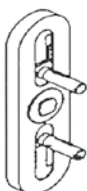

## Art. 9.0080

Gioco gratz perni.  
System for window handle.

IMBALLO 20

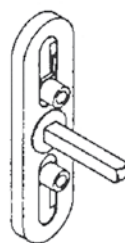

## Art. 9.0095

Gioco gratz bussola + Q7.  
System for window handle.

IMBALLO 20

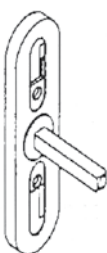

## Art. 9.0075

Gioco gratz fori + Q7.  
System for window handle.

IMBALLO 20

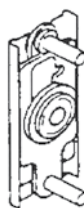

## Art. 9.0120

Gioco MP.  
System for window handle.

IMBALLO 20

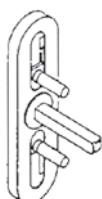

## Art. 9.0085

Gioco gratz perni + Q7.  
System for window handle.

IMBALLO 20

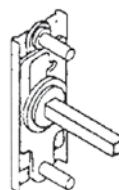

## Art. 9.0125

Gioco MP + Q7.  
System for window handle.

IMBALLO 20

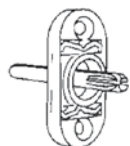

**Art. 9.0060**

Movimento DK ovale Q7x35 nylon.  
System for DK.

IMBALLO	20
---------	----

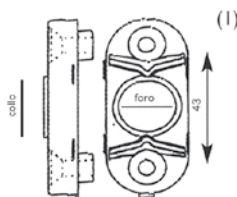

**Art. 9.0062**

Movimento DK in nylon - speciale con viti.  
System for DK.

IMBALLO	20
---------	----

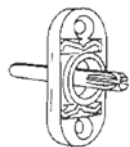

**Art. 9.0065**

Movimento DK ovale Q7x35 acciaio.  
System for DK.

IMBALLO	20
---------	----



**Art. 9.0206**

Ferro Q7 per movimenti premontati.  
System for DK.

	7x61	7x75
IMBALLO	20	20

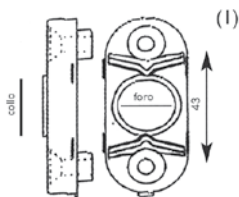

**Art. 9.0069.04**

Movimento DK acciaio premontato 4 scatti.  
System for DK.

IMBALLO	20
---------	----

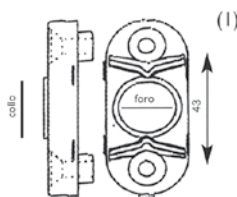

**Art. 9.0069.08**

Movimento DK acciaio premontato 8 scatti.  
System for DK.

IMBALLO	20
---------	----

# SERIE FERRAMENTAVITI



## Art. 9.0785

Confezione 2 pezzi vite per copr. Magic 3,5x9,5 mm.  
Magic switch cover screw 3,5x9,5 mm (2 pcs).

IMBALLO	2
---------	---



## Art. 9.0786

Vite per giunzione.  
Junction screw.

	4 MA	6 MA	8 MA
IMBALLO	100	100	100

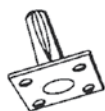

## Art. 9.0135

Piastra con  $\nabla$  8 base quadra.  
8 mm square base.

IMBALLO	50
---------	----



## Art. 9.0140

Piastrina con filetto 8 MA base tonda.  
8 mm threaded base.

IMBALLO	50
---------	----



## Art. 9.0782

Vite 4 ma x 40/50 pretagliata.  
Screw 4x 40/50 mm.

	4x40	4x50
IMBALLO	100	100



## Art. 9.0781

Vite 4 ma x 20/25/30/40.  
4 x 20/25/30/40 screw.

	4x20	4x25	4x30	4x40
IMBALLO	500	500	500	500

# SERIE FERRAMENTA/FERRI

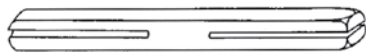

## Art. 9.0201

Ferro fresato.  
Milled square spindle.

	8x90	8x100	8x120
IMBALLO	100	100	100

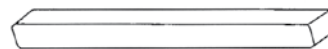

## Art. 9.0200

Ferro quadro.  
Square spindle.

	6x100	7x75	7x100	8x120	8x140
IMBALLO	100	100	100	100	100

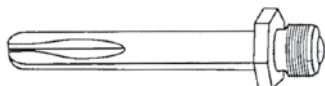

## Art. 9.0204

Ferro con nipples 10 MA.  
Nipples square spindle 10 mm.

	8x90	8x100
IMBALLO	20	20

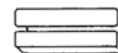

## Art. 9.0205

Riduzione plastica.  
Plastic reduction.

	da 7 a 6	da 8 a 6	da 8 a 7	da 8 a 9
IMBALLO	100	100	100	100



## Art. 9.0203

Ferro tagliato e fresato l lato con rondella in testa 8x80 mm.  
Milled square spindle with washer on head 8x80 mm.

IMBALLO	100
---------	-----



## Art. 9.0202

Ferro da espansione.  
Expansion square spindle.

	8x48	8x55	8x65	8x80
IMBALLO	20	20	20	20

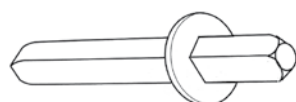

## Art. 9.0045

Ferro 7 con rondella per martelline.  
7 mm square spindle with washer for window handle.

IMBALLO	50
---------	----



DISPONIBILE SU RICHIESTA AL COSTO DI € 30.00.  
CON L'ACQUISTO DI 2 CARTONI DI MANIGLIE (50 COPPIE) VI VERRÀ  
OMAGGIATO COMPLETO DEI MODELLI SELEZIONATI.



LINEA

## *VARIANTI*

COMPOSIZIONE CODICE

MANO MANIGLIA

VARIAZIONI PREZZO

CONDIZIONI COMMERCIALI

Cottali

# COMPOSIZIONE CODICE

		A	B	C	
Es. VEGA R/B PATENT TONDA 45mm Pr. Z.CRS	1.11	61	00	32	ZA
Es. KAROL PLACCA 10 Q8 DISTANZA 90 Z.OTT	1.95	10	09	01	ZA
Es. KUBIK R/B YALE QUADRA 50x50mm Avv/ CR	MA 2.69	73	18	07	
Es. VENEZIA PLACCA 12 Q6 DISTANZA 70 ORO ANT	1.29	12	01	38	
Es. LOTUS PLACCA 16 Q8 DISTANZA 70 CR/CRS	MA 2.25	16	05	37	BIC

Le prime 3 o 5 caselle indicano il modello di maniglia.

Queste 2 caselle indicano il tipo di rosetta o placca in dotazione.

Queste 2 caselle indicano la tipologia di chiusura.

Queste 2 caselle indicano la finitura.

Queste 2 o 4 caselle per dettagli aggiuntivi.

MANIGLIE SU ROSETTA	A	B
Rosetta Tonda ø 45 mm Pressione - Staccata con Molla Incorporata	51	Foro Asola 00
Rosetta Tonda ø 50 mm Pressione - Staccata con Molla Incorporata	58	Senza Bocchetta 01
Rosetta Tonda ø 50 mm Avvitare	60	Con Nottolino WC 06
Rosetta Tonda ø 45 mm Pressione	61	Foro Yale 18
Rosetta Ovale 61x31 mm Pressione	63	
Rosetta Tonda ø 45 mm Avvitare "LUX"	65	
Rosetta Tonda ø 50 mm Pressione	68	
Rosetta Tonda ø 50 mm Avvitare "CON BORDO"	69	
Rosetta Tonda ø 50 mm Avvitare "BOMBATA"	70	
Rosetta Quadra 50x50 mm Avvitare	73	
Rosetta Quadra 50x50 mm Pressione	74	
Rosetta Quadra 45x45 mm Pressione	76	
Rosetta Rettangolare 61x31 mm Pressione	77	
Rosetta Decorata ø 60 mm	78	

MANIGLIE SU PLACCA	A	B
Placca "B" 280x55 mm	07	Q6x70 mm 01
Placca "G" 270x55 mm	08	Q8x55 mm* 04
Placca "G - BIG" 320x65 mm	08 (BIG)	Q8x55 mm 05
Placca "K" 240x42 mm	09	Q8x72 mm* 07
Placca "10" 230x38 mm	10	Q8x90 mm 09
Placca "11" 240x42 mm	11	Q8x55 mm Yale* 15
Placca "12" 247x38 mm	12	Q8x70-72 mm Yale* 17
Placca "13" 246x39 mm	13	Q8x85 mm Yale 18
Placca "Q" 243x43 mm	16	Q8x90 mm Yale* 19
Placca "17" 232x28 mm - Stretta	17	Q8x92 mm Yale* 20
Placca "19" Stampata 224x35 mm	19	Q8x55 mm WC* 25
Placca "22" Riccio 253x43 mm	22	Q8x70-72 mm WC* 27
Placca "Deco" 290x55 mm	32	Q8x90mm WC 29
Placca "R" 300x55 mm	33	Q8 Cieca 32
Placca "J" 395x75 mm	34	*Mercato Estero

## COMPOSIZIONE CODICE

		A	B	C	
Es. CREMONESE OMEGA GRAZ FIORI A.ARG	FI 2.19	10	51	75	
Es. DK SEDNA M.ACC.PREM.4.S. Q7x61 OGR	4.99	69	00	08	BD4S

Le prime 3 o 5 caselle indicano il modello di maniglia.

Queste 2 caselle indicano il tipo di rosetta o placca in dotazione.

Queste 2 caselle indicano la tipologia di chiusura.

Queste 2 caselle indicano la finitura.

Queste 2 o 4 caselle per dettagli aggiuntivi.

FINITURE	C		C
OLV (Ottone Lucido Verniciato)	01	ARG ANT (Argento Antico)	35
OF (Ottone Fumè - Solo Mod. FLORA)	02	PVD	36
BZ (Bronzato)	03	ORO ANT (Oro Antico)	38
OL (Ottone Lucido non Verniciato)	04	INOX	40/46
SAT (Ottone Satinato)	05	PL.BN (Plastica Bianca)	50
NICK MATT (Nikel Satinato)	06	PL.NR (Plastica Nera)	51
CR (Cromo Lucido)	07	BN (Bianco RAL 9010)	70
OGR (Bronzo Graffiato)	08	NR (Nero RAL 9005)	72
ANT BL (Anticato a Macchie)	09BL	ALL.ORO (Alluminio Oro)	74
ANT NV (Anticato non Verniciata)	09NV	ALL.ARG (Alluminio Argento)	75
OGR OP (Bronzo Graffiato Opaco)	18	ALL.BRZ (Alluminio Bronzo)	76
ORO 24K (Placcato Oro)	30	Porcellana OLV	90
CRS (Cromo Satinato)	32	Porcellana ANT BL	99BL

CREMONESE	B		A
Gioco GRAZ Fiori	51	Movimento Nylon R/Ovale	60
Gioco GRAZ Perni	52	Movimento Nylon Speciale c/Viti	62
Gioco GRAZ Fiori + Q7	53	Movimento Acciaio Q7x35 R/Ov.	65
Gioco GRAZ MP	54	Movimento Premontato 4/8 Scatti	69
Gioco GRAZ MP + Q7	55	Movimento Nylon R/Rettangolare	70
Gioco GRAZ Perni + Q7	61	Movimento Acciaio Q7x35 R/Rett.	75
Gioco GRAZ Bussole	62	Movimento Acciaio Q7x35 R/Rett.	75 (PES)
Gioco GRAZ Bussole + Q7	63		
Solo Q7 (Martellina)	70		

## MANO MANIGLIA



**DX**



**SX**

# VARIAZIONI PREZZO

MANIGLIE	ROSETTA 51-58-68	ROSETTA OVALE 63	ROSETTA RETT. 77	ROSETTA Q. 74-76	ROS.AVV. 60-70	ROS.AVV. 65-69
PREZZO ROS. TONDA PRESSIONE "61/68"	€ 3.00	€ 2.00	€ 6.00	€ 4.00	€ 9.00	€ 11.00

MANIGLIE	PLACCA 10	PLACCA 11-13	PLACCA 12-22	PLACCA 16	PLACCA 17	PLACCA 19
PREZZO ROS. TONDA PRESSIONE "61/68"	€ 4.00	€ 6.00	€ 8.00	€ 14.00	€ 9.00	€ 2.00

MANIGLIE	PLACCA 32	PLACCA 33	PLACCA 34	PLACCA 2.0007	PLACCA 2.0008.27	PLACCA 2.0009
PREZZO ROS. TONDA PRESSIONE "61"	€ 22.00	€ 26.00	€ 72.00	€ 7.00	€ 17.00	€ 19.00

MARTELLINE / CREMONESI	PLACCA 19	PLACCA 11	PLACCA 12	PLACCA 21	PLACCA 22	PLACCA 38
PREZZO PLACCA "10"	=	€ 2.00	€ 3.00	€ 2.00	€ 3.00	€ 4.00

DK	MOV. 62	MOV. 65	MOV. 69	MOV. 70	MOV. 75	MOV. 75 PES
PREZZO MOVIMENTO "60"	=	1.00	=	€ 1.00	€ 2.00	€ 3.00

I COSTI INDICATI NELLE TABELLE SOPRAESPOSTE SONO DA CONSIDERARSI **INCREMENTI LORDI** AL PREZZO DI LISTINO DELLA MANIGLIA IN ESAME.

Cottali

# CONDIZIONI COMMERCIALI

## ORDINI

La COTTALI SRL si riserva di accettare in tutto o in parte gli ordini che riceverà direttamente o tramite agenti di zona.

I quantitativi ordinati dovranno essere il più possibile conformi alle confezioni indicate nel presente catalogo; le quantità non conformi potranno essere automaticamente arrotondate al multiplo superiore o saranno soggette ad una maggiorazione del 10% sul prezzo del listino.

L'importo minimo spendibile è di **€ 200,00 (duecento/00)** al netto di IVA; in casi eccezionali potranno essere accettate spedizioni di importi inferiori che comporteranno le seguenti condizioni:

- addebito extra per spese accessorie pari a **€ 10,00**;
- il pagamento sarà tassativamente vincolato con **“Contrassegno”** o **“Bonifico Anticipato”**.

## PREZZI E SPESE DI TRASPORTO

I prezzi si intendono IVA esclusa e per merce Franco Fabbrica od in Porto Franco con addebito delle spese in fattura, salvo diverse comunicazioni da parte della COTTALI SRL.

## PAGAMENTI

Il pagamento delle fatture deve essere fatto direttamente alla COTTALI SRL nei metodi e tempi concordati ed inoltre:

- non sono accettate trattenute o arrotondamenti, salvo previa autorizzazione;
- il mancato pagamento, anche parziale, autorizza la COTTALI SRL a sospendere ulteriori forniture;
- in caso di Ri.Ba. impagata, l'importo dovuto verrà **TASSATIVAMENTE** aggravato di spese accessorie pari a **€ 10,00**, giustificate come sovvenienza attiva. Su richiesta del cliente le stesse potrebbero essere inserite nella fattura successiva, che comunque sarà vincolata da un pagamento con **“Contrassegno”** o **“Bonifico Anticipato”**.

## CONSEGNE

I termini di consegna sono da considerarsi puramente indicativi; il ritardato invio del materiale ordinato verrà preventivamente segnalato, ma non darà diritto ad alcun indennizzo.

Per motivi gestionali la COTTALI SRL si riserva, all'occorrenza, il diritto di invii frazionati.

Eventuali aggiunte agli ordini già in corso verranno accettate con riserva e potranno ritardare i tempi di consegna.

## SPEDIZIONI E RECLAMI

La merce viaggia sempre e comunque a rischio e pericolo del Committente, anche se la spedizione è in Porto Franco.

Eventuali reclami sono ritenuti validi solose effettuati entro 9 (nove) giorni dall'invio della merce (in tal caso fa fede la data del DDT o Fattura accompagnatoria).

Per qualsiasi controversia è competente unico Foro di Brescia.

## RESI

Trascorsi 9 (nove) giorni dall'invio del materiale, non verrà preso in considerazione alcun reso, salvo diverse indicazioni da parte esclusiva della COTTALI SRL, comunque vincolata dalle seguenti modalità:

- ogni reso dovrà essere preventivamente autorizzato **in forma scritta** da parte della COTTALI SRL;
  - dopo aver controllato ed aver riscontrato l'effettiva difettosità della merce resa, la COTTALI SRL istituirà la sostituzione immediata del materiale in questione od il rimborso del valore dello stesso;
- Per eventuali articoli “speciali” e/o “fuori standard”, approntati appositamente su richiesta del cliente, non saranno accettati resi per nessun motivo.

## NOTE

**LA COTTALI SRL SI RISERVA LA FACOLTÀ DI APPORTARE, IN QUALUNQUE MOMENTO, MODIFICHE AI MODELLI ILLUSTRATI NELLA PRESENTE PUBBLICAZIONE, PER RAGIONI INTERNE O DI CARATTERE TECNICO/COMMERCIALE, SENZA DOVERE DARE PREAVVISO ALLA ROPRIA CLIENTELA.**

# GENERAL TERMS / SALES CONDITIONS

## ORDERS

COTTALI SRL reserves to accept fully or partially all the orders received directly or through our salesman or agents.

The quantity ordered must be strictly related to the packing indicated on this catalogue.

The quantity will be automatically rounded up to the superior multiple of the foreseen packing.

We will not accept goods returned because of these rounding up.

## PRICES

The quotations indicated on the present catalogue Price list are expressed in Euro currency on Ex-Works base.

For high quantities or specific demands, please contact our Sales Department to require personalized offers.

## PAYMENTS

All payments must be remitted directly to COTTALI SRL or by swift bank transfer as we indicate on the invoice, within and not later than the date of expiry we fixed.

After this term, we will debit interest for delay based on the legal interest rate.

In case of missing or payment, COTTALI SRL is allowed to send no more goods.

## DELIVERY AND FORWARDING

Delivery terms agreed are not binding and are to be considered approximate due to production reasons or customer requirements, partial deliveries can be made. Additions of goods to the order already in progress are accepted but they can delay the terms of delivery agreed.

The goods always travel at customer's own risk, the customer is always obliged to accept the goods, on the contrary all the damages and the cost due to that missed collection will be on his own charge.

The goods are always ex-works our factory, if required we can send goods free destination with freight charged on invoice.

## CLAIMS AND REPLACEMENTS

Claims will only be accepted if received in writing within the term of 10 days from the date of receiving the goods.

If customer wants to return the goods and claims are justified, he must contact us and make agreement with our sales manager about the way of returning the goods. Return goods without our prior approval are not allowed.

If the goods are produced on Customer purpose we will not accept the return for any reason.

For any dispute, the competence belongs to the law-court of Brescia (Italy) only.

## NOTES

**COTTALI SRL KEEPS THE RIGHT TO MODIFY THE FEATURES OF ANY ITEM FOR INTERNAL, TECHNICAL OR TRADE REASONS, WITHOUT PROVIDING ANY NOTICE TO THE CUSTOMER.**



MANIGLIERIE

INTERNET: [www.cottali.it](http://www.cottali.it)  
E-MAIL: [cottali@cottali.it](mailto:cottali@cottali.it)

**Cottali** s.r.l.

Capitale Sociale € 100.000 int. vers.  
**FUSIONE E LAVORAZIONE PRODOTTI  
METALLI NON FERROSI**  
25070 BARGHE (Brescia) Italy  
Via Strada Vecchia, 3 - Tel. 0365 824317  
Fax 0365 824240 - R.E.A. 204839 - Mecc. BS021029  
C.F. e Reg. Imp. BS 00603850173 - P.I. 00572400984  
Cod. Ident. CEE IT 00572400984











